

OMNIA.9sg

Stereo Generator with Psychoacoustically-Controlled
Distortion Masking Clipper



USER MANUAL

S/W Version 3.16.50 • January 2017



Notices and Cautions

CAUTION:

The installation and service instructions in this manual are for use by qualified personnel only. To avoid electric shock, do not perform any servicing other than that contained in the operating instructions unless you are qualified to do so. Refer all servicing to qualified personnel.

This instrument has an auto ranging line voltage input. Ensure the power voltage is within the specified range of 100-240v. The ~ symbol, if used, indicates an alternating current supply.



This symbol, wherever it appears, alerts you to the presence of uninsulated, dangerous voltage inside the enclosure – voltage which may be sufficient to constitute a risk of shock.



This symbol, wherever it appears, alerts you to important operating and maintenance instructions.

CAUTION: DOUBLE POLE/NEUTRAL FUSING

The instrument power supply incorporates an internal fuse. Hazardous voltages may still be present on some of the primary parts even when the fuse has blown. If fuse replacement is required, replace fuse only with same type and value for continued protection against fire.

WARNING:

The product's power cord is the primary disconnect device. The socket outlet should be located near the device and easily accessible. The unit should not be located such that access to the power cord is impaired. If the unit is incorporated into an equipment rack, an easily accessible safety disconnect device should be included in the rack design.

To reduce the risk of electrical shock, do not expose this product to rain or moisture. This unit is for indoor use only.

This equipment requires the free flow of air for adequate cooling. Do not block the ventilation openings in the top and sides of the unit. Failure to allow proper ventilation could damage the unit or create a fire hazard. Do not place the units on a carpet, bedding, or other materials that could interfere with any panel ventilation openings.

If the equipment is used in a manner not specified by the manufacturer, the protection provided by the equipment may be impaired.

WARNUNG:

Die Installations- und Serviceanleitung in diesem Handbuch ist für die Benutzung durch qualifiziertes Fachpersonal. Um Stromschläge zu vermeiden führen Sie keine andere Wartung durch als in dieser Betriebsanleitung aufgeführt, es sei denn Sie sind dafür qualifiziert. Überlassen Sie alle Reparaturarbeiten qualifiziertem Fachpersonal.

Dieses Gerät hat eine automatische Bereichseinstellung der Netzspannung.

Stellen Sie sicher, dass die verwendete Netzspannung im Bereich von 100-240V liegt.

Das Symbol ~, falls verwendet, bezeichnet eine Wechselstromversorgung.



Dieses Symbol, wo immer es auftaucht, macht Sie auf nicht isolierte, gefährliche elektrische Spannung (ausreichend um einen Stromschlag hervorzurufen) innerhalb des Gehäuses aufmerksam. Spannungen.



Dieses Symbol, wo immer es auftaucht, weist Sie auf wichtige Bedienungs- und Wartungsanleitung hin. Lesen Sie die Bedienungsanleitung.

ACHTUNG: ZWEIPOLIGE ABSICHERUNG / NULLEITER ABSICHERUNG

Das Netzteil des Gerätes hat eine interne Sicherung eingebaut. Auch wenn die Sicherung durchgebrannt ist, können auf einigen primären Bauteilen noch gefährliche Spannungen vorhanden sein. Wenn ein Austausch der Sicherung erforderlich ist, ersetzen Sie die Sicherung nur mit gleicher Art und Wert für den kontinuierlichen Schutz gegen Feuer.

WARNUNG:

Das Gerätenetzkabel ist die Haupttrennvorrichtung. Die Steckdose sollte sich in der Nähe des Gerätes befinden und leicht zugänglich sein. Das Gerät sollte nicht so angeordnet sein, dass der Zugang zum Netzkabel beeinträchtigt ist. Wird das Gerät in ein Rack eingebaut, sollte eine leicht zugängliche Sicherheitstrennvorrichtung in den Rack-Aufbau mit einbezogen werden.

Um die Gefahr von Stromschlägen zu verringern, darf dieses Produkt nicht Regen oder Feuchtigkeit ausgesetzt werden. Dieses Gerät ist nur für die Benutzung im Innenbereich. Dieses Gerät erfordert freie Luftzirkulation für eine ausreichende Kühlung. Blockieren Sie nicht die Lüftungsschlitze auf der Geräteoberseite und den Seiten des Gerätes. Unzureichende Belüftung kann das Gerät beschädigen oder Brandgefahr verursachen. Platzieren Sie das Gerät nicht auf einem Teppich, Poster oder andere Materialien welche die Lüftungsöffnungen beeinträchtigen könnten.

Wird das Gerät anders als in der, vom Hersteller angegebenen Weise verwendet, kann der, durch das Gerät gegebene Schutz beeinträchtigt werden.

USA CLASS A COMPUTING DEVICE INFORMATION TO USER. WARNING:

This equipment generates, uses, and can radiate radio-frequency energy. If it is not installed and used as directed by this manual, it may cause interference to radio communication. This equipment complies with the limits for a class a computing device, as specified by fcc rules, part 15, subpart j, which are designed to provide reasonable protection against such interference when this type of equipment is operated in a commercial environment. Operation of this equipment in a residential area is likely to cause interference. If it does, the user will be required to eliminate the interference at the user's expense. Note: objectionable interference to tv or radio reception can occur if other devices are connected to this device without the use of shielded interconnect cables. Fcc rules require the use of shielded cables.

CANADA WARNING:

“This digital apparatus does not exceed the class a limits for radio noise emissions set out in the radio interference regulations of the Canadian department of communications.”

“Le présent appareil numérique n'émet pas de bruits radioélectriques dépassant les limites applicables aux appareils numériques (de class a) prescrites dans le règlement sur le brouillage radioélectrique édicté par le ministère des communications du Canada.”

CE CONFORMANCE INFORMATION:

This device complies with the requirements of the EEC council directives:

- ◆ 93/68/EEC (CE MARKING)
- ◆ 73/23/EEC (SAFETY – LOW VOLTAGE DIRECTIVE)
- ◆ 89/336/EEC (ELECTROMAGNETIC COMPATIBILITY)

Conformity is declared to those standards: EN50081-1, EN50082-1.

TRADEMARKS

Omnia Audio and the Omnia logo are trademarks of TLS Corp. All other trademarks are the property of their respective holders.

NOTICE

All versions, claims of compatibility, trademarks, etc. of hardware and software products not made by TLS Corp which are mentioned in this manual or accompanying material are informational only. TLS Corp makes no endorsement of any particular product for any purpose, nor claims any responsibility for operation or accuracy. We reserve the right to make improvements or changes in the products described in this manual which may affect the product specifications, or to revise the manual without notice.

WARRANTY



Telos Alliance Radio Division has an industry-leading five-year warranty. As a company, we are committed to our products and the pursuit of providing better quality to our customers.

Find the Warranty online at www.telosalliance.com/warranty.

UPDATES

The operation of Omnia.9sg is determined largely by software. We routinely release new versions to add features and fix bugs. Check the Telos Alliance web site for the latest. We encourage you to sign-up for the email notification service offered on the site.

FEEDBACK

We welcome feedback on any aspect of Omnia.9-SG, or this manual. In the past, many good ideas from users have made their way into software revisions or new products. Please contact us with your comments.

SERVICE

You must contact Omnia before returning any equipment for factory service. We will need your unit's serial number, located on the back of the unit. Omnia will issue a return authorization number, which must be written on the exterior of your shipping container. Please do not include cables or accessories unless specifically requested by the Technical Support Engineer. Be sure to adequately insure your shipment for its replacement value. Packages without proper authorization may be refused. US customers, please contact Omnia Technical Support at +1-216-622-0247. All other customers should contact local representative to make arrangements for service.

TECHNICAL SUPPORT

You may reach our 24/7 support team around the clock by calling +1-216-622-0247 or by email at support@telosalliance.com. A variety of useful information is available on the Telos Alliance website (www.telosalliance.com/omnia).

ADDITIONAL CONTACT INFORMATION AND SUPPORT

For billing or non-emergency technical questions, call +1-216-241-7225 between 9:30am and 6:00pm USA Eastern time, Monday – Friday.

Our fax number is +1-216-241-4103.

General questions can be sent by email to inquiry@telosalliance.com.

Our mailing address is The Telos Alliance, 1241 Superior Avenue E., Cleveland, OH, 44114, U.S.A.

PRODUCT REGISTRATION

Did you know that all Telos Alliance products come with a 5-year warranty? Take a moment to activate your coverage online at <http://telosalliance.com/product-registration/>.

Table of Contents

	<i>User Warnings and Contact Info</i>	II
	Register You Product	V
	A Letter from our CEO, Frank Foti	VII

1	<i>Overview and Applications</i>	<i>1</i>
	Overview	1
	Applications	2
	Features.	5
	More About Selected Features	6
	Psychoacoustically-Controlled Distortion Masking Clipper	6
	Psychoacoustic Composite Embedder	6
	RF Bandwidth Controller	6
	SSB (Single Sideband) Stereo Subcarrier Options	7
	ITU-R BS.412 MPX Power Controller	7
	Auto Pilot Stereo/Mono Switching	7
	Full Remote Control	8
	Omnia Toolbox	8
	Internal Playback with Processing.	9
	Local Audio Insertion with Processing	9
	Livewire+/AES67 Multicast Compliance	9
	GPI/O and SNMP Support	10

2	<i>Quick Start Setup Guide</i>	<i>11</i>
	Physical Installation	11
	Front Panel Control, Menu Navigation, and Password	12
	Using the Rotary Encoder	12
	Unlocking the Unit	13
	Front Panel LEDs (And Our Version of a Secret Decoder Ring).	14
	Configuring Network Settings and Installing NfRemote	15
	Configuring I/O Sources and Settings.	16
	Select the Input Audio Source	16
	Adjust the Input Gain	17
	Configure and Adjust the Output	18

	Adjusting the Composite Output	18
	Using the Omnia Direct™ Output	19
	Adjusting FM Diversity Delay	19
	Using ITU-R BS.412 (MPX Power Limiting)	20
<hr/>		
3	<i>Omnia.9sg Settings</i>	21
	Omnia.9sg Menu	21
	Stereo Generator Menu	21
	Load Preset Menu	22
	Save Preset Menu	23
	Input Selection Menu	23
	Input Adjust Menu	26
	Livewire Input Menu	27
	Livewire Output Menu	28
	MPX Menu	29
	Digital Output Menu	30
	Auto Pilot Menu	31
	Power Limit Menu	31
	Clipper Menu	32
	TCP Link Status Menu	34
	MPX Inputs Menu	40
	MPX Input 1/MPX Input 2 Menus	40
	Local Processor Menu	41
	Load Preset Menu	42
	Save Preset Menu	42
	Preset Protection Menu	43
	About Preset Menu	43
	Input Conditioning Menu	44
	Enhance Menu	44
	Gain Riding Menu	45
	Multiband Menu	46
	Bypass Menu	46
	Clipper Menu	47
	Meter Options Menu	48
	RDS Menu	49
	RDS Main Menu	49
	RDS Station ID Menu	51

	Program Type Menu	52
	Flags Menu	52
	Alternative Frequencies Menu	53
<hr/>		
4	<i>Monitor Outputs</i>	54
	Headphone/Speaker/Aux Output Menu	54
	Patch Point Menu	55
	Load Preset Menu	56
	Save Preset Menu	57
	Main Menu	58
	Loudness Menu	61
	Left/Right EQ Menu	63
<hr/>		
5	<i>System Settings</i>	64
	System Status.	64
	System Information	64
	CPU Cores	64
	Network Information.	64
	Audio I/O Status	64
	Monitor Out Status (1/2)	64
	Current Alarms	64
	Scheduling	65
	GPI/O	66
	GPI Menu	66
	GPO Menu	67
	System Configuration	68
	Password	68
	Time/Date	68
	Power	69
	IP Configuration	69
	Outbound Connection	70
	HTTP Access	71
	Software Update.	71
	Backup	72
	SNMP.	72
	Upgrades	73

6	<i>Client Audio</i>	74
	Client Audio Out.	74
	“Patch Point” Menu	74
	Client Mic Input	75
	Input Device.	75
	Load/Save Preset	75
	Main	75
	EQ	75
	Client File Recorder	76
	Client IP Options	76
<hr/>		
7	<i>Frequently Asked Questions</i>	77
	What is this thing and what exactly does it do again?	77
	I don’t have an Omnia.9—Can 9sg still benefit me?	77
	What about RDS?	77
	What else have I won, Bob?	78
	So I’ve read through this entire manual and I STILL have questions. Now what?	78
<hr/>		
8	<i>Specifications</i>	79
<hr/>		
9	<i>Telos Alliance Warranty</i>	81

War of the Waves

Dear Valued Customer,

It's with great pride and a tip of the hat to an incredible team that I congratulate you on your new Telos Alliance product. Everything we do here at the radio division of the Telos Alliance is with one end goal in mind: To help broadcasters declare victory in extremely competitive environments. By purchasing this product from us, in essence, you have declared war on your competition.

After all, the majority of Telos Alliance employees were broadcasters themselves once, and the products we've developed over the years have been designed as solutions to specific issues faced on the front lines of our industry. We're right there in the trenches with you and have the weapons you need in your arsenal.

Telos Systems is a catalyst to out-of-this-world sound, with the most powerful and popular broadcast telephone systems in the industry; IP/ISDN codecs and transceivers; plus processing/encoding for streaming audio. We built an industry on the back of these amazing telephony systems, and they are still going strong.

While we at the Telos Alliance never forget our roots, we are also blazing trails in terms of new technologies like stream-encoding and AoIP, so that all types of broadcasters can excel in this ever-evolving digital world.

Omnia Audio not only lets you stand out on the dial with your unique signature sound via legendary audio processors, audio codecs, and microphone processing, it lets you give your listeners a better streaming experience across devices with innovative stream encoding/processing software and hardware.

Axia Audio is a driving force behind the AES67 AoIP standard, and its networked AoIP radio consoles, audio interfaces, networked intercom, and software products continue to move AoIP adoption forward and help broadcasters streamline operations with cohesive, smart, and feature-rich AoIP ecosystems.

Last, but certainly not least, **25-Seven** has traditionally been known for its audio delays, but its Voltair watermark monitor/processor has made a name for itself more recently as the disruptive product that helped broadcasters take back their ratings and harness the true power of their listening audiences.

You work so hard on your programming day-in and day-out, it deserves technology that will optimize sound and performance at every point in the airchain and online. Armed with Telos products, you have what you need to set your competition squarely in your crosshairs.

With that, I'll leave you to prep your armaments. I hope that you will enjoy your Telos Alliance products for many years to come!

Sincerely,
Frank Foti

CEO, The Telos Alliance



1 Overview and Applications

Overview

Since the late 1970's, most FM audio processors have been “all-in-one” units; audio conditioning, multiband AGC, multiband limiting, final clipping, and stereo (MPX) encoding are all in the same chassis. This approach offers many benefits in convenience, performance, and cost and has worked well with traditional composite STL systems or when the processor can be placed at the transmitter site.

One important fact about Omnia.9sg is that it is “processor agnostic” – that is, it can be used with any processor from any manufacturer. This ability allows stations to significantly upgrade their processing power and audio quality without having to invest in an entirely brand-new processor. Or, you may simply prefer the dynamics processing (AGCs and limiters) from another brand or model but still want to take advantage of the superior composite abilities of Omnia.9. Details about using Omnia.9sg in such applications are provided later in this manual.

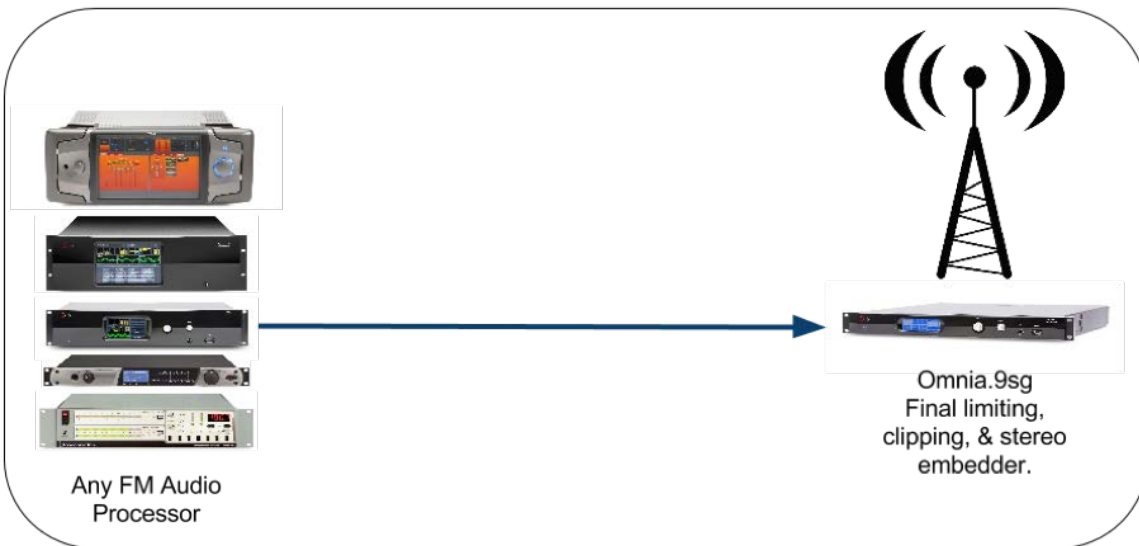

Applications

In many cases, it is advantageous to place the main audio processor at the studio while the final clipper and stereo generator operate at the transmitter such as when using a discrete analog or digital (AES) STL.

If the STL delivers bit-reduced audio using a lossy codec to optimize available bandwidth, overshoots are possible which result in lost loudness from the final transmitted signal.

In this case, proper FM clipping must be applied after the coded link where advanced stereo generation can add an additional dB of loudness with no further audio degradation.

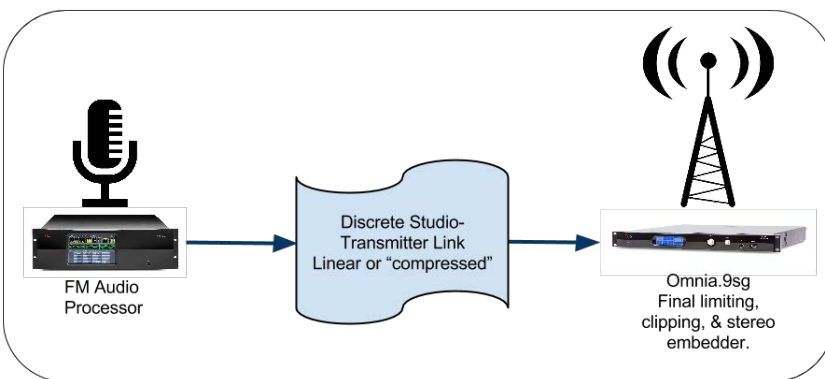

Some FM broadcasters are transmitting the same audio from two or more tower sites. In these cases, one primary audio processor can feed a WAN or satellite distribution system while individual Omnia.9sg's reside at each transmission site.

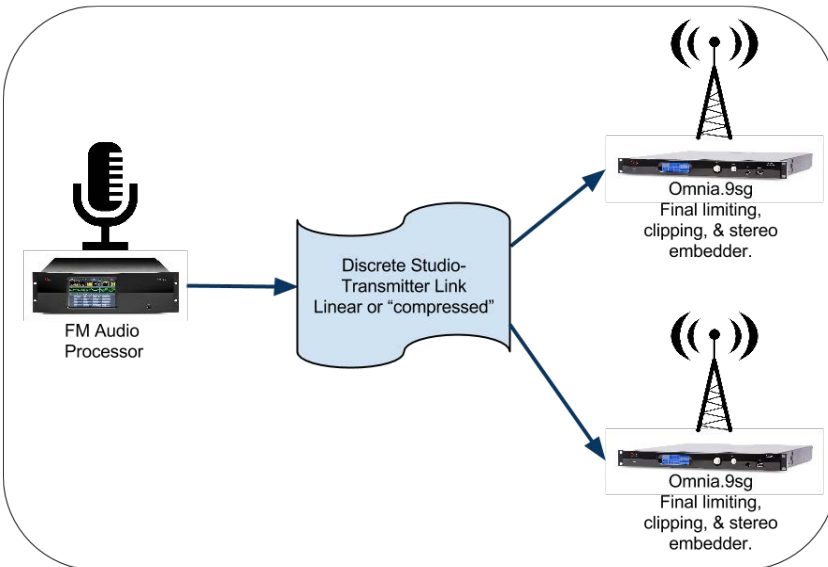

Transmitter sites are often remotely located and sometimes shared among multiple broadcasters. Access may be limited and tightly controlled. In such cases, keeping the main processor at the studio and installing a smaller and less expensive stereo encoder makes sense.

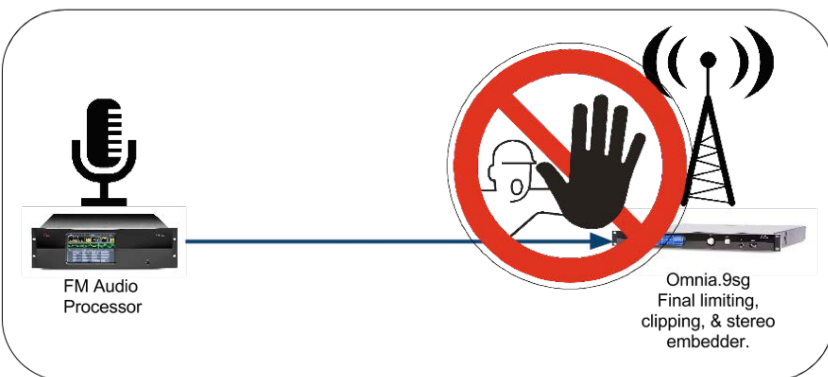

Stations employing main and backup STL's for redundancy feeding the same or geographically different transmitter sites can also benefit from Omnia.9sg by allowing the use of a single processor at the studio.

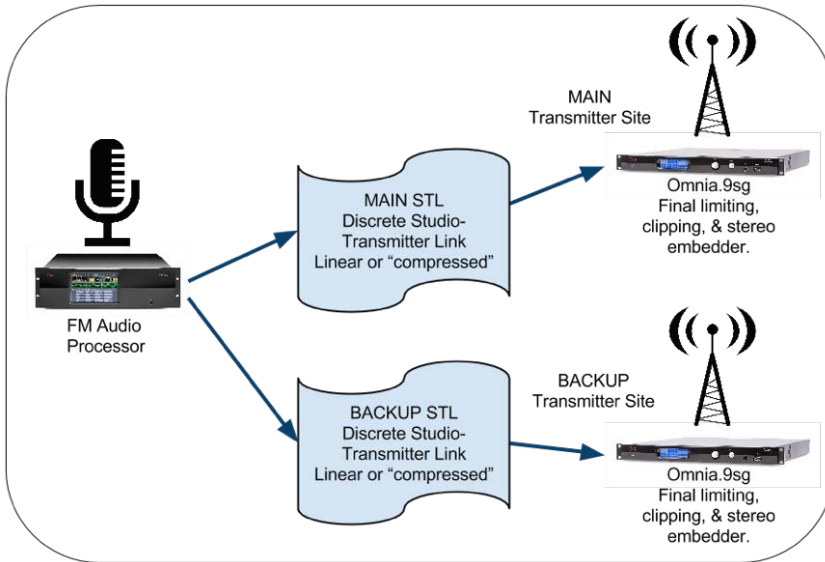

Research has indicated that ratings encoders and/or ratings enhancement devices (such as our own Voltair) benefit from being fed processed audio. While some processors including Omnia.9 and Omnia.11 have special “insert points” designed for this purpose, not all processors do. Placing the processor and ratings encoder at the studio and moving the stereo generator to the transmitter site can help accommodate this.

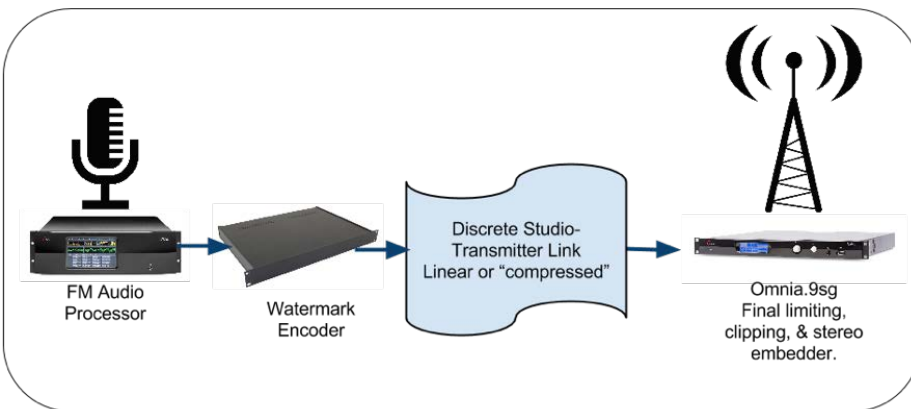

Features

Omnia.9sg includes many of the composite-side features of our Omnia.9 processor but with an improved version of the psychoacoustically-controlled distortion masking clipper and composite embedder that contribute so significantly to Omnia.9's clean on-air sound.

These include:

- ◆ Full IP remote via NfRemote app with remote audio streaming
- ◆ Built-in http server with push support for automation, including dynamic RDS data such as artist and song titles
- ◆ Selectable SSB (single sideband) stereo encoding
- ◆ RF Bandwidth controller to reduce multipath distortion
- ◆ Optional RDS encoder (field updateable)
- ◆ ITU-R BS.412 power limiter
- ◆ Auto Pilot (turns off pilot for mono content)
- ◆ Relay bypass including composite pass-through
- ◆ “Omnia Toolbox” analysis tools (oscilloscope, FFT, RTA)
- ◆ Dual redundant power supplies
- ◆ Analog and AES3 audio I/O
- ◆ Two composite outputs (one swappable to 19kHz reference output)
- ◆ Two composite inputs (for RDS or backup processor)
- ◆ Internal playback with processing
- ◆ Optional local audio insertion feature with processing
- ◆ Livewire+/AES67 multicast compliance
- ◆ GPI and GPO support
- ◆ SNMP support

More About Selected Features

Psychoacoustically-Controlled Distortion Masking Clipper

Believe it or not, the description “psychoacoustically-controlled distortion masking clipper” is more than just high tech marketing speak! It actually sums up the premise of how Omnia.9sg’s clipper is able to deliver such a clean sound even when pushed for competitive loudness.

All FM processors use clipping in their final stage as a means of building loudness and providing absolute peak modulation control. The majority of clipping is typically done in the final L/R stage with additional (and optional) clipping being performed in the composite domain.

This is also where the classic (and oft dreaded) “loud v. clean” tradeoff is made. When more clipping is used to increase loudness on the dial, the clipped peaks fall back into the audio and manifest themselves as audible distortion.

There are ways to get around that problem, but they come at a price. Backing down the clipper drive will clean up the sound, but then you lose loudness. You could move more of the “heavy lifting” to the compressors and limiters, but that can result in an overly-busy, dense sound that robs the music of life and invites listener fatigue. Indeed, some processors MUST resort to building density in this way because their simple or outdated clippers must be protected or simply aren’t up to the job.

Like any other clipper, the one in Omnia.9sg clips peaks and generates distortion – but it can identify that distortion and use its proprietary algorithms in the composite signal to mask it, effectively eliminating it from the final audio.

As a result, this advanced clipper comes closer to eliminating the “either/or” compromise between loudness and audio quality than any other processor on the market today.

Psychoacoustic Composite Embedder

Another trick Omnia.9sg has up its sleeve is its ability to get 140% L/R audio peaks while maintaining 100% total modulation, even with the challenging 75 microsecond pre-emphasis curve. This results in 1dB of extra loudness without any additional processing or clipping and allows Omnia.9sg to be significantly cleaner for a given loudness level, or, substantially louder for a given level of quality – especially in the higher frequencies.

RF Bandwidth Controller

By using a built-in software-based FM exciter and spectrum analyzer, Omnia.9sg can analyze and measure the predicted occupied bandwidth of the real-world FM signal and communicate this information to the final clipper so that bandwidth can be optimized in real time.

This is useful in situations where a signal with wider RF bandwidth and a receiver with a narrow front end “collide” and result in increased distortion and the loss of part of the signal.

When pushing hard for loudness, using the RF Bandwidth Controller can result in a slight loudness loss (approximately 0.5dB) and some loss of stereo separation, so its application and any resulting tradeoffs will be largely market-dependent.

The RF Bandwidth Controller is also useful for correcting anomalies such as single-channel DC offset or for optimizing modulation performance per ITU Recommendation 1268; details can be found here:

https://www.itu.int/dms_pubrec/itu-r/rec/sm/R-REC-SM.1268-3-201408-I!!PDF-E.pdf

SSB (Single Sideband) Stereo Subcarrier Options

Some improvements in FM stereo reception are possible by reducing or eliminating the upper sideband of the stereo subcarrier in the FM baseband signal. This mode is called Single-Sideband Suppressed Carrier or SSBSC.

Background information on the concept is available in this white paper:

<https://www.telosalliance.com/images/Omnia%20Products/White%20Papers/MPX-SSB-White-Paper.pdf>

Omnia.9sg offers three different SSBSC filtering modes, allowing users to choose which is most appropriate in their market. Details of each are provided later in this manual.

ITU-R BS.412 MPX Power Controller

The Power Controller provides the ultimate combination of loudness and modulation while still ensuring compliance with applicable BS.412 regulations, required by some countries or regions.

Auto Pilot Stereo/Mono Switching

Broadcasting in stereo is obviously a sonic advantage for 2-channel content, but it's far from a "free ride". For example, the stereo pilot typically claims 9% of the total modulation, stereo signals are more prone to multi-path distortion than mono signals, and the signal-to-noise ratio for stereo is worse than for mono.

If you are playing stereo music these are acceptable tradeoffs but operating in stereo brings nothing to the table for mono content, be it mono music or talk programming.

Using the Auto Pilot feature in Omnia.9sg allows the pilot to be automatically turned off (resulting in mono transmission) when the source audio is detected to be mono, lowering the noise floor by 20dB, virtually eliminating multipath distortion when it is most audible, and utilizing the modulation normally reserved for the pilot for the audio. When the content returns to stereo, the pilot automatically and seamlessly turns back on.

Full Remote Control

Every modern processor provides some means by which to control it or adjust its settings remotely, which is handy if it is located at a remote transmitter site miles (and often mountains) away from the studio.

Most employ web-based interfaces which on the surface sounds convenient because it allows you to remote in from a browser on any computer at any location, but even the best of them fall short when it comes to a great user experience. They require browser plug-ins, typically feel “laggy” when viewing meters or adjusting controls, and don’t always have the same look and feel as the front panel interface.

Omnia.9sg’s NfRemote client software not only allows the same level of control as offered from the front panel, but is actually easier to navigate whether you’re standing next to Omnia.9sg or controlling it from miles away.

If you have Omnia.9sg’s on more than one station in your group (who can buy just one?) you can connect to any of them through a single connection window, and can run multiple remotes simultaneously.

Providing your network has sufficient bandwidth, you can even stream audio from various patch points within the processing chain back to the client computer. This allows you to hear what effect your adjustments have on your audio in the environment of your choice instead of a rack room or transmitter building, locations which almost never have decent monitors but offer noise in abundance!

Omnia Toolbox

When creating Omnia.9sg, we recognized that having advanced diagnostic and measurement tools would be necessary. Audio processing is largely a “hearing” process but there is much to be learned by also seeing what your adjustments are doing to your sound.

Some stations still have an oscilloscope on the test bench or a spectrum analyzer at the transmitter, but it’s not always convenient (or possible) to hook up a processor to them while it’s on the air. Even if you did so, you’re pretty much limited to monitoring only the composite output of your own station’s processing.

Omnia.9sg’s built-in Toolbox solution means there’s no extra test equipment to buy (‘scopes and analyzers aren’t cheap) and no cables to hook up. It also means you can visually monitor the signal at the input, the output, and many points throughout the processing path so you can tell what’s happening to the audio every step of the way.

As an added bonus, Omnia.9sg’s composite inputs can be fed from a calibrated tuner or frequency-agile mod monitor so that you can monitor competitor’s signals in your market too!

Internal Playback with Processing

The loss of source audio for whatever reason – STL packs it in, automation system takes a dirt nap, talent locks themselves out of the building taking a smoke break, studio is being fumigated again – means Omnia.9sg will have no processed audio to include in its composite signal.

To temporarily get you through such a situation, Omnia.9sg now thoughtfully includes the ability to play and process back-up audio from internal storage if the primary source audio is interrupted. The internal player is not designed to replace an automation system, but it can randomize music and insert liners and legal IDs.

Files can be uploaded via FTP server and can hold approximately 15GB of music in MP2, MP3, FLAC, or WAV (PCM only) formats.

The built-in processor is a 2- to 4-band variation of the dynamics processing found in Omnia.7 and Omnia.9 and comes with over twenty newly created presets designed to work with Omnia.9sg's clipper.

Local Audio Insertion with Processing

The optional local audio insertion feature allows an additional external audio source to replace main program audio either automatically or by a proprietary cue tone which can be downloaded from the Omnia website at TelosAlliance.com/Omnia. A look-ahead feature ensures that the cue tones are never audible on-air.

This system – which uses the same built-in processing as the internal playback feature - is particularly valuable for networked applications where the majority of content is relevant to all affiliates or transmitter sites but where it is beneficial (or even legally required) to replace specific network content with local program elements such as local ID's, weather, traffic, commercials or locally produced public service content.

Having the option for local processing is also valuable if the loss of primary audio content from the studio is expected to last an extended period of time, for example, during construction, if the studio cannot be occupied or there is a complete failure of the console, automation system, or STL. In this case, feeding the output of a small mixer or a stand-by automation system directly into Omnia.9sg can get the station back on the air until the issue can be resolved.

Livewire+/AES67 Multicast Compliance

Omnia.9sg is Livewire+/AES67 multicast compliant, and includes support for SDP (Session Description Protocol) files. It provides three universal, assignable inputs and nine dedicated outputs.

Outputs include dozens of patch points from within three Monitor Output points, a decoded MPX output from the Omnia.9sg's stereo generator, a decoded MPX output from a mod monitor feeding either of the external composite inputs, and – as a world's first – a full composite signal over Livewire+/AES67 via a 192kHz 16-bit single channel stream.

GPI/O and SNMP Support

Omnia.9sg now supports both GPI and GPO via dedicated physical connections and over Livewire.

A pre-defined list of GPIs is provided later in this document, and the ability to write customized task scripts has been added. This allows any control value or function to be changed via a GPI command by creating a customized task script through Omnia.9sg's built-in http server. Multiple commands can be combined into a single script, allowing complex combinations of parameters to be changed all at once.

GPO options include a number of critical hardware and signal-related conditions which can be assigned to trigger alternate signal routing or equipment use.

All GPOs plus many more alarm conditions are available as SNMP traps to be read by your external SNMP management software. Omnia.9sg supports SNMP v1 and v2c.

2 Quick Start Setup Guide

We've prepared this preliminary Quick Start Setup Guide to get you and your new Omnia.9sg up and running as quickly as possible.

It is deliberately brief and does not provide a full explanation of all available controls and settings, so we strongly recommend reading the complete user manual when time allows.

Omnia.9sg is a slim 1RU design so it doesn't take up much vertical rack space, but it is deep. Accordingly, you may wish to enlist the help of an assistant when racking it up and ensure there's nothing to obstruct it toward the back of the rack.

The unit is fan cooled but leaving an empty rack space directly above and below it is still good practice for both Omnia.9sg and the equipment directly above and below it. Air is drawn in via an intake near the front right side of the unit (looking at the front panel) and exhausted near the front left side, so ensure there are no obstructions around these areas that would impede air flow.



Physical Installation

Connect AC power to both of the internal power supplies. There is no power switch.

It is always possible for a power supply to fail; having redundant supplies helps protect you in the unlikely event that one of the internal supplies fails. . In reality, external power source failure is far more likely. , Good engineering practice dictates that each supply should be fed from a different source. At minimum we recommend that each source should be a good quality UPS with adequate surge protection. In an ideal world (where everyone gets along and you got to build the plant of your dreams from scratch with an unlimited budget) each would be fed from a completely different isolated circuit for maximum redundancy.

Next, connect the audio inputs as appropriate for your installation. Omnia.9sg accepts balanced professional line-level analog audio via its Left and Right Analog Inputs and AES/EBU digital audio on standard XLR connectors via its AES inputs. Audio can also be provided via Livewire.

Two composite (MPX) inputs are also provided and can accept a full MPX signal from the composite output of another processor.

In the event of a power (or software) failure, Omnia.9sg provides a hard relay bypass. When the bypass relay is engaged, MPX Input 1 is directly connected to MPX Output 1 while MPX Input 2 is directly connected to MPX Output 2. Accordingly, it is possible to take the composite output of a hot backup processor or stereo generator and feed it into the MPX input corresponding to the employed MPX Output.

The main AES XLR input can accept audio with or without a clock reference of between 32kHz and 96kHz. If necessary, the built-in sample rate converter (SRC) on this input will up- or down-convert to the fixed system standard of 48kHz.

A dedicated external reference input is provided on the rear panel via a BNC connector should it be necessary to sync to a clock that is not present on the incoming AES audio signal, but this must be a 48kHz signal as no SRC is present on the BNC input. An adapter (Pin 2 hot, Pin 3 shield) may be used for short runs without concern. For longer runs, a transformer may be used.

Front Panel Control, Menu Navigation, and Password



Using the Rotary Encoder

Much like our Omnia.7 processor Omnia.9sg uses a “joystick” type of rotary encoder for menu navigation and control adjustment on the front panel.

- ◆ “Rocking” the control left, right, up or down facilitates navigation through the various menus. In lower level menus, a Right command is a backspace, while a Left command is Enter or proceed.
- ◆ Turning the knob clockwise or counterclockwise scrolls through tables and adjusts individual controls. Turn the knob to rapidly navigate through the alpha-numeric selector page.
- ◆ Push the rotary control in to press “Enter”. This “Enter” action usually has the same function as rocking the control to the right.

Unlocking the Unit

For newcomers, navigating using the Rotary Encoder can take some getting used to. Getting past the password lock provides a first step to becoming familiar with navigation tools. This step-by-step guide will help give you an orientation.

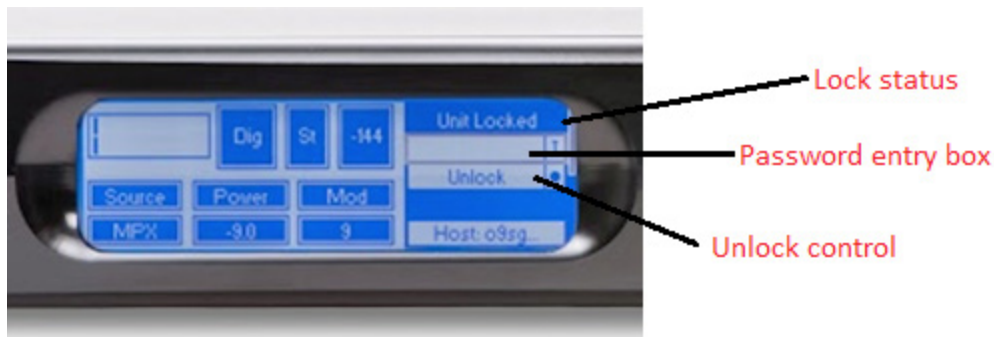

- ◆ Rock the rotary encoder up/down control so you highlight (draw the grey outline) around the Password entry box.
- ◆ Press Enter to proceed to the Alpha-numeric selection page.
- ◆ Turn the knob to select letters and numbers, then press Enter to “type” characters. The factory default password is “1234”. When you are finished entering your password, scroll to “OK” and press Enter. This will return you to the screen above, and you’ll see hidden characters <...> in the Password entry box.
- ◆ Rock the control down to highlight the Unlock control, then press Enter. If your password was valid, this will take you to the 9sg System Menu.

Once you are in the System menu, use the same controls to navigate through choices, and familiarize yourself with the menu structure. In many cases, you may simply want to proceed to the System/System Config/IP Config menu to set network addresses, then use NfRemote for the rest of your setup. Note that the unit will always lock itself when the display times out and goes dark. The length of time before this happens is adjustable in the System > System Config > Power menu. The default timeout is the maximum 24-hour duration.

While front panel navigation is always an option, primary setup and configuration is much more easily accomplished via the free NfRemote software application available from the Omnia.9sg product page on the TelosAlliance.com website. All screenshots and visual references within this document are taken directly from the NfRemote interface.

NfRemote allows you to quickly navigate all the layers of 9sg software, and provides a richer, more complete display of controls. We recommend you use it as your primary interface with the unit.

Front Panel LEDs (And Our Version of a Secret Decoder Ring)



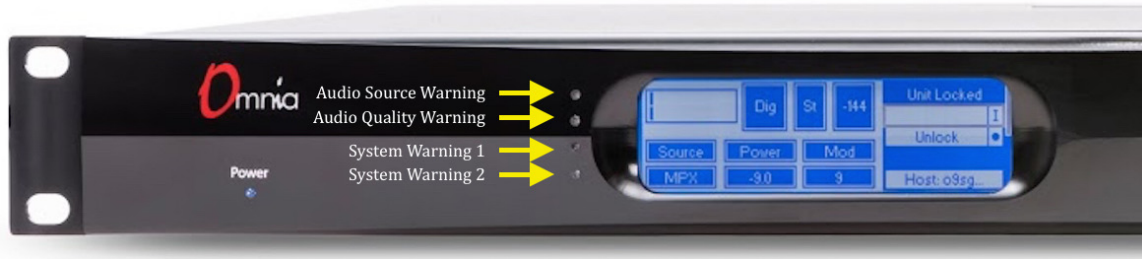





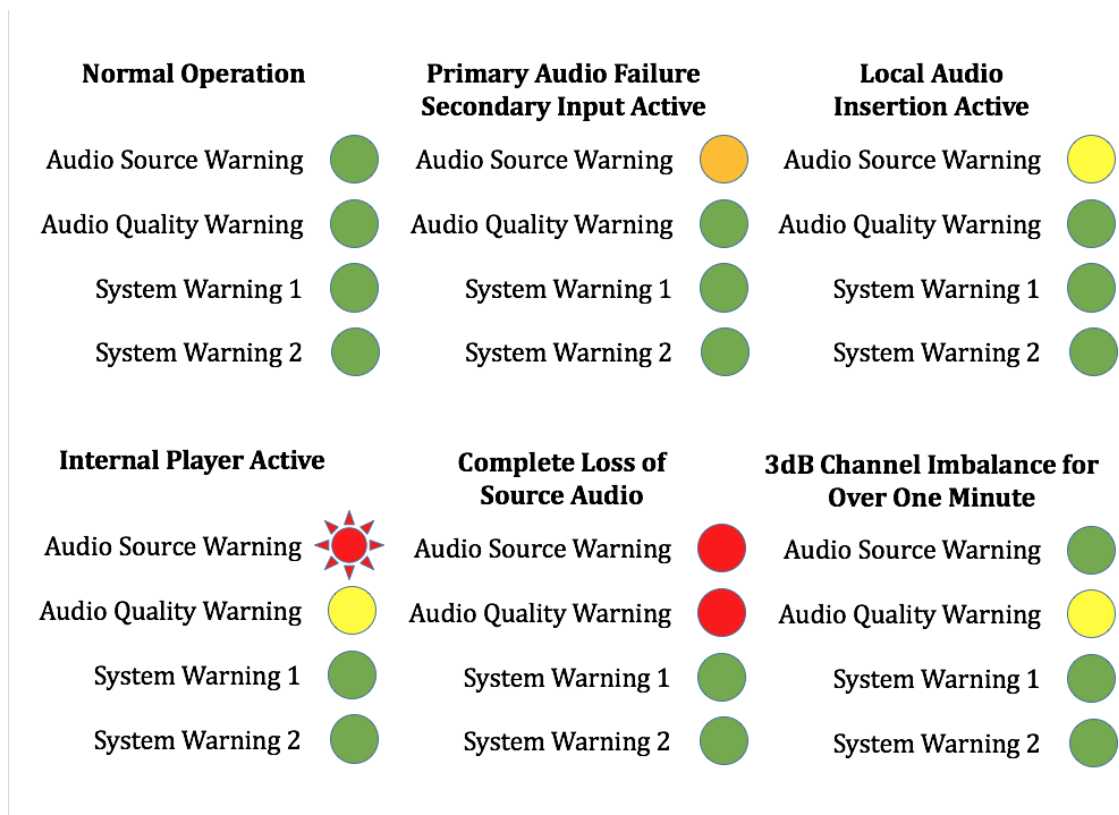



The front panel features four LEDs that serve as status indicators for various audio and hardware conditions.







The top two LEDs denote audio conditions and alarms, the “Audio Source Warning” and “Audio Quality Warning” indicators. The bottom two are system status and alert indicators, “System Warning 1” and “System Warning 2”.

In normal operation, all indicators will show green. The meanings of various colors and combinations are explained below in a visually pleasing, easy-to-follow diagram.



Audio Input Overload	Chassis Cooling Fan Failure	CPU Overheating
Audio Source Warning 	Audio Source Warning 	Audio Source Warning 
Audio Quality Warning 	Audio Quality Warning 	Audio Quality Warning 
System Warning 1 	System Warning 1 	System Warning 1 
System Warning 2 	System Warning 2 	System Warning 2 

Chassis Overheating
Audio Source Warning 
Audio Quality Warning 
System Warning 1 
System Warning 2 



Configuring Network Settings and Installing NfRemote

Connect Omnia.9sg to your local network via the rear panel Ethernet connection. The unit is set up to receive an IP address via DHCP by default. Navigate to **System > System Configuration > IP Configuration** from the Main Menu and verify that an IP address has been assigned. This may take a minute or two depending upon your network. Note that the DHCP display will not show an IP address when unplugged from the network.

A static IP address can also be assigned by navigating to **System > System Configuration > IP Configuration > Use DHCP** and click the joystick right to un-check it. Then navigate down and click-right on the IP: box, enter the desired IP address and click-right on OK when done. Similarly, enter the Subnet Mask and other network parameters (if required). Finally, navigate to **Apply** and then click-down all the way past the warning text and you'll see "Are you sure?", highlight the Yes box and click-right.

Copy the NfRemote application to a Windows laptop, desktop, or tablet from the USB thumb drive supplied with your unit, or download it from the Omnia website. Double-click to begin the installation and follow the on-screen directions to complete it.

When the NfRemote connection screen appears, enter the IP address and password of your Omnia.9sg. You may also fill in a "friendly" name in the Comment field to help identify the unit.

Be sure to click on the dropdown menu to the far right of the connection window and choose the correct input method (local mouse, remote desktop/VM, touch screen, etc.)

You may click on the “Add” button to add this unit to a quick recall list in the bottom of the window or simply click “Connect”.

Once the connection is complete, the main Home screen will appear. Clicking the left mouse button highlights displays, menu items and controls. Clicking and holding the left mouse button while dragging adjusts sliding controls.

Configuring I/O Sources and Settings

Omnia.9sg makes the perfect “split chassis” solution for customers who want the benefits of having their main processor at the studio without sacrificing the advantages of having the composite generator at the transmitter.

Accordingly, its default settings presume that the “FM Pre-final L/R” output insert point found on Omnia.9 and Omnia.7 or the “PP” patch point output of the Omnia.11 (running version 3.0 software or higher) will be used to feed Omnia.9sg.

Select the Input Audio Source

Navigate to the Omnia.9sg > Stereo Generator > Input Selection menu and select the proper source (analog, AES digital, or Livewire) for the primary and/or backup inputs. Only the primary input is required. If a backup source is provided, it can be used as a failover source in the event of a loss of audio on the primary input.

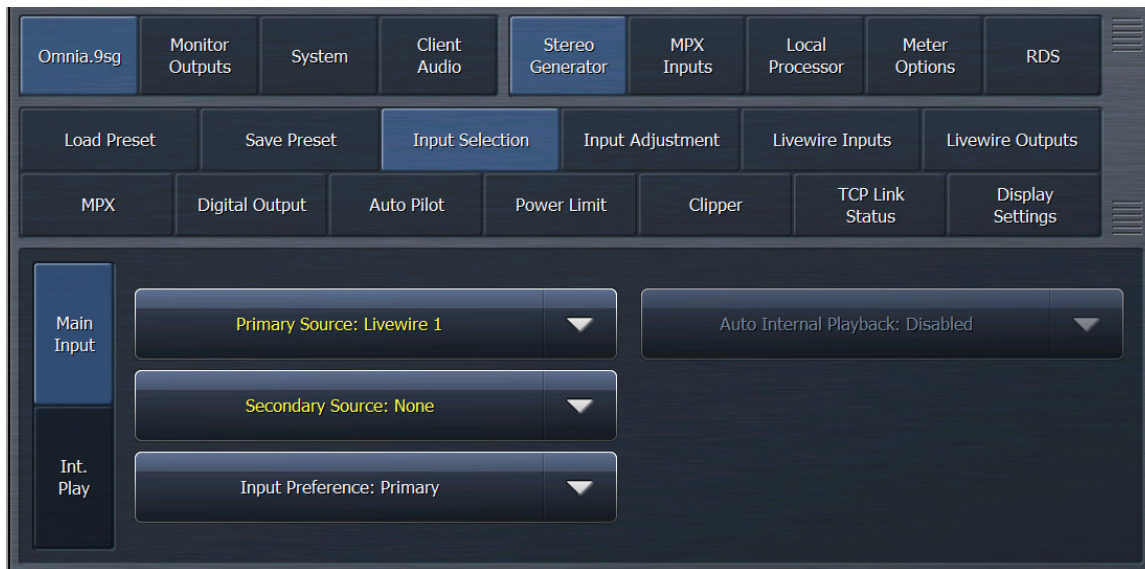

Adjust the Input Gain

From the Omnia.9sg > Stereo Generator > Input Adjustment menu, set the “Input Gain” control as appropriate for your input source and processing needs.



NOTE:

The “Input Gain” control on Omnia.9sg adjusts the input drive level to the clipper and therefore replaces the more traditional and familiar “Clipper Drive” control found on a traditional FM processor. Accordingly, increasing this control increases clipper drive.

By default, this control is set to +12.5dB as it is presumed Omnia.9sg will normally be fed from an Omnia.9 using the “FM Pre-final L/R” patchpoint output which has been attenuated by the same amount to provide adequate headroom.

When set at the default level, this will exactly emulate the sound and behavior of a standalone Omnia.9 using its composite outputs. Accordingly, any adjustments to the Omnia.9’s “Final Clip Drive” control will yield identical results.

This setting also holds true if you are feeding Omnia.9sg from another processor with a similar “post-limiter, pre-clipper, pre-emphasis” patchpoint, providing it applies the same pre-attenuation.

If you are feeding the 9sg with a processor that does not have such a patchpoint, the best performance will be realized by using its HD output. The limiter drive on the processor feeding 9sg should be turned down well below where it would typically be run, since the final clipper in 9sg will do the “heavy lifting”, and take into account the pre-emphasis curve.

Finally, it is also possible to use a “flat” (non-pre-emphasized) FM output to feed Omnia.9sg or even a de-emphasized FM output (with the final clipper drive of the processor turned all the way down) but this approach would have a negative impact on overall audio quality due to the 15 kHz low pass filtering typically present in most processors. The 16.5 kHz low-pass filter of 9sg will allow significantly more high end through the system if it is fed directly without additional prior filtering.

Configure and Adjust the Output

Connect the audio outputs as appropriate for your installation.

Two composite outputs are provided to feed a main/backup composite STL or transmitter.

Omnia.9sg also supports balanced professional line-level analog audio via its Left and Right Analog Outputs and AES/EBU digital output on standard XLR connectors via the AES output. The AES outputs can also be used to provide an Omnia Direct™ (composite over AES) signal.

Adjusting the Composite Output

To adjust the levels of each of the composite outputs, navigate to the Omnia.9sg > Stereo Generator > MPX menu and adjust the corresponding “MPX Output Level” sliders until the desired modulation is indicated on a dedicated, calibrated modulation monitor. The “Pilot Level” and “Pre-emphasis” controls are also found here. Details of other controls will be explained in detail later in this manual.



Using the Omnia Direct™ Output

If the AES outputs will be used to feed an Omnia Direct signal, navigate to the Omnia.9sg > Stereo Generator > Digital Output menu and choose the appropriate source to feed the digital output.

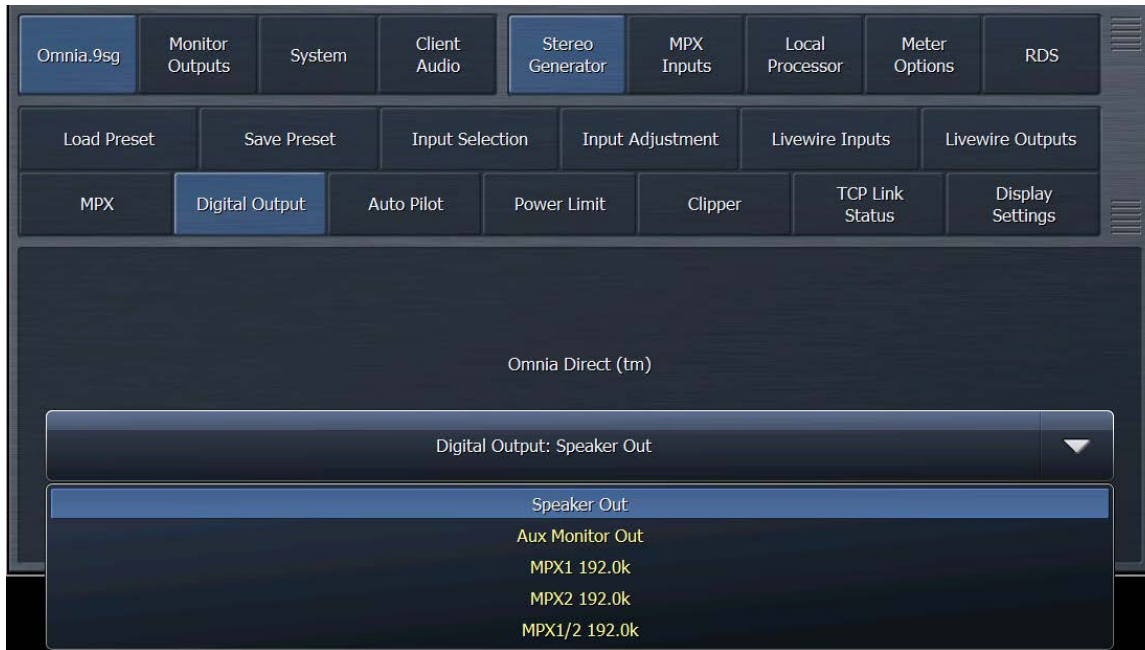

Adjusting FM Diversity Delay

If the output of Omnia.9sg needs to be delayed to match an HD signal, the adjustment can be made in the Omnia.9sg > Stereo Generator > Input Adjust menu. Separate adjustments are provided for the digital and analog inputs. Double-clicking on the “Diversity Delay” slider will provide coarse, medium, and fine adjustment sliders to make adjustment easier.



Using ITU-R BS.412 (MPX Power Limiting)

Omnia.9sg supports ITU-R BS.412, a regulatory mandate in some countries which requires that average MPX power be limited to a particular standard and measured with a rolling 60-second integration time.



If Omnia.9sg is used in conjunction with Omnia.7 or Omnia.9, the BS.412-specific presets in those processors should be used.

Any adjustments to the MPX power limiter should be made in the Omnia.9sg via the controls in the Omnia.9sg > Stereo Generator > MPX Power Limit menu. Please note that it may be necessary to set the “MPX Power Limit” slider to very different levels than the settings in the processor’s preset to achieve the same power output level.

3 Omnia.9sg Settings

In this chapter, we will take a more detailed look at the various menus, sub-menus and controls of Omnia.9sg—starting with the “Omnia.9sg” menu. This chapter will also cover basic navigation.

The menus – shown here in the “tabbed navigation” style which is selectable from the “Menu” button at the top of the NfRemote screen, are hierarchal in nature, with highest order controls starting at the top left, and lower, more subordinate controls at the bottom.

In the illustration below, the highest level controls (“Tier 1”) are outlined in red, followed Tier 2 outlined in yellow, then Tier 3 in green, and finally Tier 4 in orange. Not all Tier 3 menus will have a Tier 4 sub-menu, but some do. At the “bottom” of each menu/sub-menu you will find the individual controls, outlined here in blue.

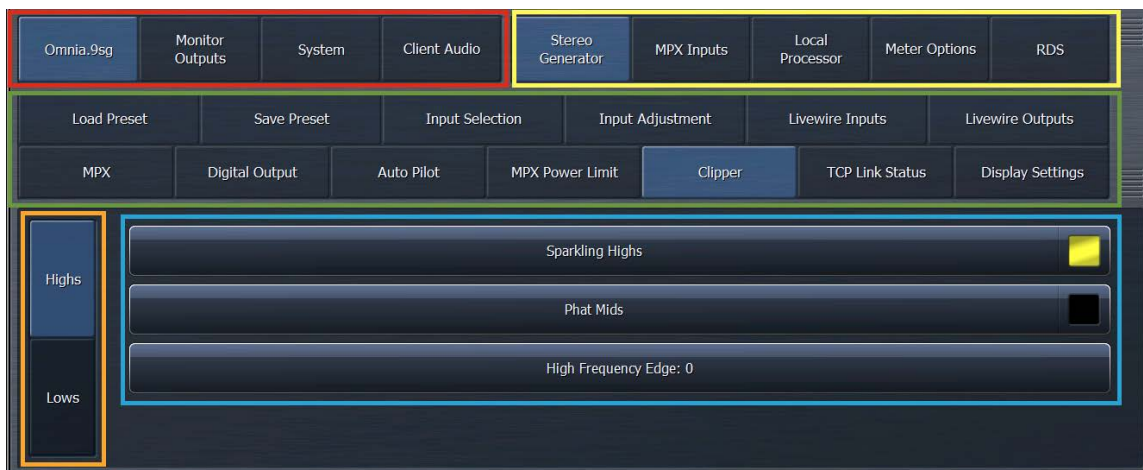

Omnia.9sg Menu

This menu contains the sub-menus and controls for the stereo generator, composite inputs, meter options, and both internal and external RDS settings.

Stereo Generator Menu

This sub-menu contains the controls for loading and saving presets, configuring and adjusting the inputs, configuring and selecting the outputs, and other composite related items such as Auto Pilot, MPX power limiting, and the controls to fine tune the clipper.

Load Preset Menu



Once you have made changes to the various controls and settings, you will likely want to save those for easy and instant recall. These presets can then be recalled via the “Load Preset” menu. A list of available presets appears on the right side of the screen. Those displayed in white are factory presets. Those displayed in yellow are user presets.

- ◆ The “Current Preset” window shows the preset currently in use.
- ◆ Clicking on the “Recall Backup” button will place the preset listed into the “current” location, allowing you to toggle back and forth between two presets.
- ◆ Clicking on the “Diff Preset” button allows you to view differences between the current and backup preset, providing neither have been modified and not saved. Control settings from the current preset that are different from the backup preset will be displayed in yellow.
- ◆ The “Delete Preset” button removes tough stains from your laundry. (OK, it actually deletes the currently highlighted preset from the list, but sometimes a technical writer grows weary of explaining the obvious and gets a little cranky). Bear in mind that the currently loaded preset will remain active if deleted until another preset is recalled, but will no longer be available for recall once another preset replaces it.
- ◆ The “Load From” button allows a preset saved to the PC running NfRemote to be loaded into the Omnia.9sg. This is handy for uploading a configuration saved to that PC from another unit. Remember that “Load From” immediately loads the preset into the current preset slot, and that the preset must be saved on the Omnia.9sg itself from the “Save Preset” menu in order to be available from the list of presets to the right of the controls. If you need to manage presets without actually placing them on the air, you can do so through the http interface.

Save Preset Menu



This is where you can save any customizations or changes you've made to the controls in the "Stereo Generator" section.

- ◆ Clicking on "Save Preset" after typing the name of your choosing into the text field will create a preset which can later be recalled from the list on the right side of the screen.
- ◆ The "Save to PC" button saves the preset file to the location of your choice on your PC so that it can be shared or uploaded to other Omnia.9sg units.

Input Selection Menu

Main Inputs

The primary and secondary inputs, either digital, analog, or Livewire, are chosen here. It is not necessary to provide a secondary input but doing so allows an alternate audio source to be placed on the air should the primary source be interrupted.



- ◆ The "Input Preference" control has two settings, "Primary" and "Current", and controls the behavior of the input source switcher when primary audio returns after being interrupted.
- ◆ Choosing "Primary" places the primary audio source back on the air as soon as it is again available. Selecting "Current" will keep the secondary source on the air even after the primary source returns.

Local Input

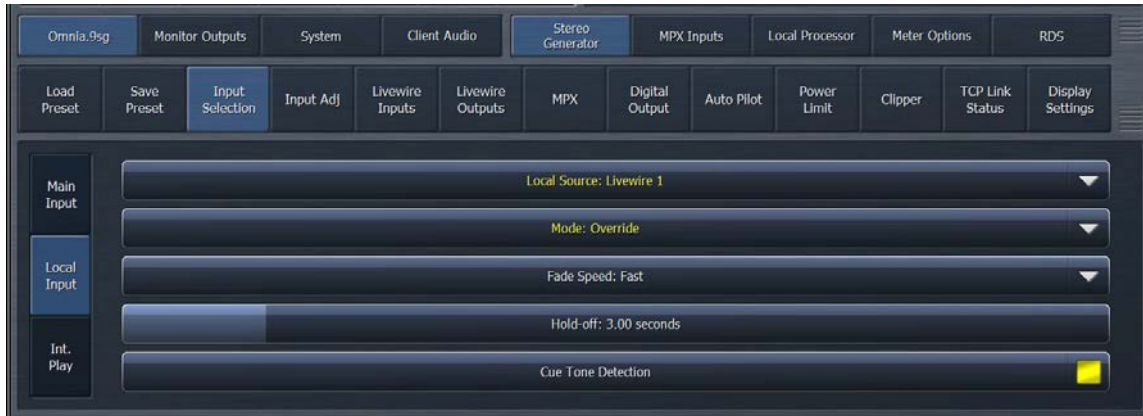

Optionally, Omnia.9sg offers the ability to route an external or “local” audio source into the built-in processor and in turn to the clipper/stereo generator. In addition to the standard internal playback function, this feature provides yet another source of backup audio (plus processing) should both the primary and secondary audio sources fail.

It can also be used to localize particular content such as IDs, liners, news, traffic, weather, or commercials.

- ◆ The “Local Source” drop down menu offers access to the same physical input sources as the main inputs – Digital, Analog, and one of three Livewire feeds.
- ◆ The “Mode” control affects how and when the source selected in the “Local Source” menu behaves.
 - ◇ “Off” turns off the local input completely and is the default value.
 - ◇ Selecting “Mix” provides a full-time mix of the main input (which is routed directly to the clipper and bypasses the local processor) and the local input (which is routed through both the local processor and the clipper). Put another way, both the main input and the local input are both “hot” at all times. This mode can be useful when the main network feed goes silent during local breaks, but it assumes both the network silence and the local break are perfectly timed to avoid dead air or source audio crashes.
 - ◇ “Override” mutes the main audio input and activates the local input source, essentially allowing Omnia.9sg to operate as a standalone processor.
 - ◇ “Vox” mode (“Voice Activated Switch”) listens for and gives priority to the presence of audio on the local source; if audio is present, the local source goes on the air; when the local source goes silent, the audio source selected in the Main Input menu resumes.
 - ◇ “Backup” mode is the opposite of “Vox”; it listens for and gives priority to the presence of audio on the main source; if the main source is silent but the local input has audio, the local source goes to air; when the main audio source returns, local is interrupted and the main source goes to air.

- ◆ All input switching modes operate with a cross-fade; the speed at which the cross fade occurs is adjustable by the “Fade Speed” drop down menu. When in “Vox” mode, there is an internal look-ahead (delay) on the Local Input to ensure a perfect cross-fade as the main audio will begin its fadeout before incoming local audio airs.
- ◆ The “Hold Off” control determines how many seconds of silence are allowed before switching from the Local Input back to the Main Input audio.
- ◆ If you are using the Internal Input as a backup audio source, then a certain period of waiting would be acceptable. If you are using it to insert local content into a network window, however, this would be unacceptable. Therefore it is possible to dynamically cancel this waiting period by enabling “Cue Tone Detection” and inserting a set of proprietary cue tones at the end of the local break (available as .wav or .mp3 files on the TelosAlliance.com/Omnia website); because of the look-ahead feature on the Local Input, the cue tones are never heard on-air.

Internal Playback



Omnia.9sg also offers an internal playback feature designed to keep you on the air in the event the primary and secondary sources become unavailable, perhaps due to the failure of an STL or a play-out system at the studio.

The internal player is not an automation system but it can randomize music and guarantees not to repeat a song within twenty songs (provided you have more than 20 songs in the folder). It can also periodically insert station liners, jingles, or legal IDs. It will not crossfade songs, but will automatically trim any silence at the beginning and end of each track to provide tight back-to-back playback.

Content is uploaded to the internal SSD via the built-in FTP server on port 7321 (passive ports 7322-7331). The default user name is either anonymous or “Omnia” There is no password as access is controlled by the HTTP Access “white list” in the System > System Configuration > HTTP Access menu.

The internal drive can hold roughly 15GB of music in MP2, MP3, FLAC, or WAV (PCM only) formats. The FTP server will refuse any file that is not a supported type.

Each root folder is available from the Folder drop-down menu. A folder for Station IDs is automatically created.

- ◆ The “Gain” control sets the output level of the internal player.
- ◆ The “Play” button manually starts the internal player.
- ◆ “Auto Internal Playback” allows the internal player to start automatically when it detects the loss of audio from the primary or secondary sources; the amount of time it waits to begin playback is selectable; internal playback will stop when audio returns to the primary or secondary input.
- ◆ The “Previous” and “Next” buttons allow you to play the next or last song.
- ◆ The “Mode Selector” provides playback options. “File” simply plays one cut until it is over and then stops. “Folder” plays the entire contents of a folder in order and stops. “Repeat File” and “Repeat Folder” repeats either a single cut or the contents of a folder respectively. “Randomize Folder” plays the entire content of the folder but in a random order.
- ◆ The frequency of station ID insertion is determined in the “Station IDs” drop-down menu.

Input Adjust Menu



All controls affecting the signal at the input of the clipper are located here.

- ◆ “Input Gain” - which as noted earlier in this manual is the same as the “Clipper Drive” control in a traditional, integrated processor – sets the amount of overall clipping. The default “unity” value of 12.5dB should be used with processors whose insert point outputs are pre-attenuated by this amount, such as Omnia.7 and Omnia.9. When using a processor with an output that has not been pre-attenuated, this control should be set to +3.0dB as a starting point with the final limiter or clipper drive on the processor feeding 9sg backed off as much as possible. Again, you will want to back off the DRIVE to the limiter and/or clipper on that processor and NOT simply adjust its post-clipper output gain.
- ◆ The “Balance” control can be used to compensate for a left/right channel imbalance on the incoming signal.
- ◆ The “Diversity Delay” control sets the amount of delay in the analog FM composite signal so that it can be time-aligned to a corresponding HD-1 signal.

- ◆ “Invert” reverses the phase of one or both input channels.
- ◆ The “Channels” menu allows the left and right channels to be swapped, summed together (mono), or permits either the left or right input to be placed on both channels feeding the stereo encoder.

Livewire Input Menu



Omnia 9.sg offers yet another powerful and convenient feature. Here you can take any Livewire or Livewire+ / AES67 channel from your Axia network to feed into the Omnia 9.sg. There are three Livewire inputs that can be setup. Each input can be assigned to a unique Livewire or Livewire+ channel. Furthermore, each input can act as a five-channel selector. This can be used to make quick selections of common Livewire channels that would be desired to feed the Omnia 9.sg. These route changes may also be automated via task scripts mentioned later in this manual or with Axia Pathfinder.

An example would be if a main and backup processor existed at the main studio site and needed to be failed over. These backup feeds could both be on their own Livewire or Livewire+ / AES67 channels and seamlessly picked to feed the Omnia 9.sg, via Input 1. If a secondary backup studio location, also with a main and backup processor existed – the same thing could be setup on Input 2 for a dual redundant scheme.

A running display of real time data is shown on this screen as well to help with troubleshooting network path problems. A Fifo buffer can be adjusted to mitigate audio issues if jitter values are too high over the network.

With Livewire+ / AES67 MPX baseband may also be sent and received over the network and fed directly into either of the two Omnia 9.sg’s MPX inputs. These options are accessible by opening MPX Input 1 and MPX Input 2 screens and assigned a valid MPX over Livewire+ / AES67 source. Please note, that when a Livewire channel is assigned to MPX Input 1 or MPX Input 2 this will override the physical composite input.

To assign a Livewire channel to a bank. First click on the Channel List button and a new window appears with all advertised Livewire channels. Select the desired channel and press OK. Alternatively, if you know the channel number ahead of time you can key that in and simply press the Take button. Then press the Assign button, the box will glow yellow. Then simply click on any of the Livewire preset buttons below to set it to that button.

“Destination Name” field is used in conjunction with Axia Pathfinder routing software. An Axia Pathfinder server can directly manipulate the Livewire input of the Omnia 9.sg. This name will appear in the Destination column of an Axia Pathfinder audio router. If the field is omitted the name will be shown as either Input 1, Input 2, Input 3, MPX Input 1 and MPX Input 2.

Livewire Output Menu



Multiple Livewire outputs from various paths within the Omnia 9.sg can be generated and sent to the network. The Overview screen will allow you to see what Livewire channels are currently being generated, and from which source or path within the unit the channel will contain.

Setting a Livewire destination is a straightforward process. For typical outputs such as “Speaker Out” or “Aux Out” there are just a few parameters to set. A Channel number must first be chosen, make sure this does not conflict with any Livewire channel numbers already in use on your network. After keying in a channel number, press the Take button to set it.

- ◆ The “Name:” field will set the friendly text name for the channel as advertised to the network. The “Label:” field will add more detail in parentheses after the friendly channel name. If the Label field is omitted, the source name such as Speaker Out or MPX Out will be used instead. ‘Name (Label)’ is how the text will read as this channel is advertised to the Livewire network.
- ◆ The “Enable” button, when selected will start broadcasting the Livewire channel to the network. The “Stream Mode” drop down box allows the Livewire stream to be in Standard mode or Low Latency mode. For sources that will be monitored in real time such as Headphones or Speaker Out, Low Latency would be applicable.

MPX signals can now also be sent over the Livewire+ network.

- ◆ “MPX Out”, “MPX Input 1” and “MPX Input 2” selections will include the full baseband signal into its respective Livewire channel. These are setup almost identical to the regular Livewire audio streams. Please note that the Stream Mode options are called “MPX Std” and “MPX Low Latency” instead.
- ◆ The Clock menu will allow selection of either the standard Livewire clock method or using PTP IEEE 1588 clock source. Please contact support if you feel that this mode needs to be set to PTP.

MPX Menu



Adjustments that affect the normal composite outputs and the Omnia Direct composite over AES outputs are found here.

- ◆ The “MPX 1 Output Level” and “MPX 2 Output Level” controls determine the output modulation of the corresponding rear panel outputs.
- ◆ The “MPX 1 Output Mode” and “MPX 2 Output Mode” controls determine which composite signals are routed to the output including the processed input signal or composite inputs from other processors via the MPX inputs on the rear panel.
- ◆ The “MPX Test Generator” section contains tones and sweeps that are useful for testing and proofing transmission path components.
- ◆ The “RF Bandwidth Controller” feature is described in detail in Chapter 1, but to summarize, it can be used to measure and manage the occupied bandwidth of the composite signal. This is especially helpful for keeping receivers with a narrow “front end” happy, for helping mitigate multipath distortion, and for optimizing modulation performance per ITU Recommendation 1268.
- ◆ The “Stereo Encoding” control is set to the usual dual sideband operation by default.

Selecting “Single Sideband Standard” completely turns off the upper sideband, but as some receivers will switch to mono in this mode, two other options are available that offer a compromise by allowing audio below 12kHz to occupy both lower and upper sidebands while restricting audio above 12kHz to occupy only the lower.

“Single Sideband Smooth 12K” skews its slope more toward a true single sideband model while “Single Sideband Steep 12K” gets closer to the traditional dual sideband mode.

- ◆ Omnia.9sg’s composite embedder, as mentioned in Chapter 1, is capable of generating L/R peaks well in excess of 100% while still maintaining 100% total modulation. This ability provides up to 3dB of extra headroom in the clipper, especially at higher frequencies, which allows for a very clean and open high end even when processing aggressively.

However, some receivers don't handle this additional L/R modulation as well as others and so the "Clipped Demodulated Peaks" adjustment is provided to control the extent to which the L/R clipper is allowed to exceed 100%. A value of 1.0 allows L/R peaks of no more than 100%; a value of 1.5 allows L/R peaks of up to 150%.

- ◆ The "Pre-Emphasis" control enables and selects a pre-emphasis curve. Ideally, Omnia.9sg will be fed with flat, non-pre-emphasized audio so that proper pre-emphasis can be performed internally using either a 50us (for Europe) or 75us (for U.S.) curve. However, a flat output can be selected if desired.
- ◆ The "Pilot Level" control – as much to our surprise as yours – adjusts the percentage of pilot injection into the composite signal. In an ironic twist, higher values equate to higher pilot injection. Setting this control to 0% will disable the pilot output completely.
- ◆ The rear panel "MPX Input" jacks can be used to pass through an SCA signal (including DARC) in the 60 – 90kHz range. The signal is digitized and brick-wall filtered, then passed through to both the analog BNC composite and Omnia Direct (MPX over AES) outputs. Individual inputs or a combination of both are selectable from the "SCA Mode" menu while levels are controlled by the "SCA Gain" slider.

Digital Output Menu



The source feeding the rear panel AES Digital Output is set here and includes Omnia Direct, which allows a composite signal from Omnia.9sg to be carried on a single AES-EBU cable connection between the stereo generator and an Omnia Direct-enabled transmitter.

Additionally, audio from any patchpoint available in the "Speaker Out" or "Aux Out" menus (discussed in detail later in this manual in the chapter on "Monitor Outputs") can be routed to the AES output.

Auto Pilot Menu



As explained in detail earlier in the manual, Auto Pilot allows the stereo pilot to be turned off when source material is mono and seamlessly re-enabled when the source is stereo, providing significant improvements to noise levels and multipath distortion.

- ◆ This feature is toggled on and off by the “Auto Pilot” control.
- ◆ The “Stereo Sense” control determines the level at which stereo audio in conjunction with a mono source (such as a soft stereo music bed running under an otherwise dry voice) is considered true stereo. Higher settings make the switching more sensitive to such stereo content and will accordingly turn the pilot back sooner.

Power Limit Menu



ITU-R BS.412 standards require the average MPX power to be limited to a particular standard and measured with a rolling 60-second integration time. It is assumed that whatever processor is feeding Omnia.9sg will employ processing presets optimized for power limiting.

- ◆ The power limiter is enabled/disabled using the “MPX Power Limiter” control.
- ◆ The “MPX Power Limit” control is used to set the desired power level which can be displayed in any of the “Modulation Monitor” displays. Setting up and understanding these (and other) displays is covered in detail in the chapter on “Display Settings”.
- ◆ Selectable “Standard” or “Aggressive” limiter styles are offered. As expected, “Standard” is the gentler and less audible of the two, while “Aggressive” allows levels closer to the targeted power limit to be maintained but at the possible expense of more audible limiter action.

Clipper Menu



The clipper menu contains controls that allow the sound and texture of the clipper to be fine tuned. Please remember that the overall clipper drive is determined by the “Input Gain” control in the “Input Adjust” menu.

Highs Menu



These controls affect the sound and texture of middle and higher frequencies.

- ◆ Enabling the “Sparkling Highs” control preserves the openness and enhances the texture of very high frequencies, especially when the incoming program material has a high degree of high frequency content.
- ◆ “Phat Mids” warms up and enhances mid-range frequencies, particularly male and lower female voices. Please note that “Sparkling Highs” must be enabled for “Phat Mids” to be selectable; if “Phat Mids” is enabled and “Sparkling Highs” is turned off, the “Phat Mids” indicator will remain yellow and switch back on when “Sparkling Highs” is re-enabled, but will be grayed out and removed from the audio path until such time.
- ◆ The “High Frequency Edge” control sets tradeoff between highs that are always clean and free from distortion and a consistent high frequency output at the expense of distortion. A setting of “0” will yield the cleanest highs but with less overall brightness. A setting of “100” will result in a uniformly bright sound but at the risk of more audible distortion, and sounds more like the original Omnia.9 clipper when pushed for loudness.

Lowes Menu



These controls affect the texture and feel of the bass clipper and are sub-divided into two groups: “Bass Intermodulation Protection” and “Bass Shape”

The controls in the “Bass Modulation Protection” section are primarily responsible for distortion management, particularly intermod distortion, and for the behavior of the bass clipper.

- ◆ Unless you specifically want the presence of intermodulation distortion (where strong low frequency material can attenuate or audibly distort higher frequencies) we strongly recommend the “Intermod Distortion Protection” control be left enabled.
- ◆ The “Clip Threshold” control is the point at which bass clipping will occur under normal circumstances and is analogous to a traditional “bass clipper threshold” control.
- ◆ When bass at the level set by the “Clip Threshold” control would cause audible IM distortion, it will instead be clipped at the point determined by the “Protection Threshold” control. Note that if both the “Clip Threshold” and “Protection Threshold” controls are set to the same value, the bass clipper will operate in the traditional manner with a fixed threshold in all cases.
- ◆ The “Punch Threshold” control allows the initial edge of the bass waveform to be clipped at a different threshold for extra bass punch; the amount of time this threshold is active is determined by the “Punch Duration” slider.

The controls in the “Bass Shape” menu help set the “texture” of the bass.

- ◆ Unlike most bass clippers, the one in Omnia.9sg can (but does not have to) create a square wave when processing strong low frequency content. Setting the “Bass Shape Strength” control at “0” (0%) will always prevent square waving the bass resulting in a very smooth low end texture, but one that does not offer the “slam” of a traditional Omnia clipper even on the initial peak of a bass transient waveform. Advancing the control toward “1” (100%) will produce more square waves, increasing the bass “punch” and overall loudness, but at the possible expense of more distortion in the low end.
- ◆ The “Bass Shape Frequency” control sets the frequency of the highest harmonic produced by the bass clipper. Higher settings will produce more and higher harmonics and create a more complex and frequency-rich bass sound.

TCP Link Status Menu



Please note that this menu is available in multiple places throughout the user interface but we encounter it here first, so we will cover now but not again in subsequent chapters.

This status screen provides a comprehensive look at various parameters in the NfRemote connection to Omnia.9sg including the ping time between the host PC and Omnia.9sg, the bandwidth of the connection, the rate and amount of sent and received data, and the duration of the NfRemote session.

Given adequate bandwidth, audio streamed back from the Omnia.9sg to the host PC by the “Client Audio” service (details of which are provided in the chapter on Client Audio) will be lossless in nature and is indicated in the “Audio Format” field.

A data compressed (lossy) coded version of the audio will be created if the network bandwidth cannot provide a reliable audio stream with linear audio. The software can dynamically adjust as network speeds vary.

Display Settings Menu

Like the “TCP Link Status” menu, the “Display Settings Menu” appears in multiple locations throughout the UI but will be described in detail only once.

The display windows for Omnia.9sg within NfRemote are highly configurable and can be customized to show a wealth of information from the so-called “Omnia Toolbox” including input level meters, output LKFS loudness levels, modulation figures, and information from various patch points from within the signal path as represented on a digital oscilloscope, FFT, or RTA.



A row of six “Display Preset” buttons is located at the top right corner of the NfRemote display, outlined here in red. Each display preset can show up to eight display windows, outlined here in green. The number of simultaneous displays used in each preset will depend primarily upon monitor size as adding displays reduces the size of each individual window and will, on smaller monitors, quickly make them less readable and useful.

Note that the proportional size of the upper, middle, and lower sections of the screen can be adjusted by clicking and dragging the two resize bars (outlined in orange). This allows more or less space to be devoted to the displays, menus, and controls as needed.

Clicking on the “Display Settings” button from within any menu that offers it will immediately bring up the display settings controls as will clicking on any of the displays themselves at any time. The active window will feature a yellow box around it and its control will be highlighted in the control portion of the screen.

The menus and sub-menus to the right of the eight display buttons determine what will be displayed in any particular window. A detailed description of all possible displays follows here.

Meters

This section has displays for pre-final audio (just before the clipper), processing meters for the local processor, and I/O signal metering.

- ◆ The “Pre-Final Meters” display shows the audio levels just ahead of the final clipper plus an LKFS loudness measurement, whether the input is mono or stereo. A power limiter meter is also provided if the MPX Power Limiter is enabled.

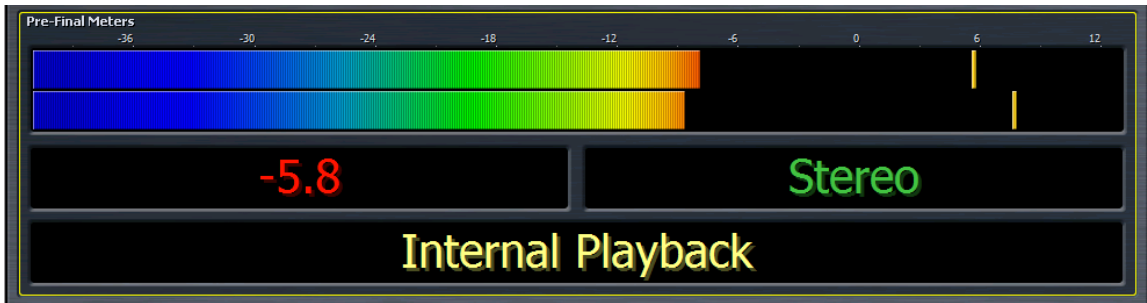

- ◆ The “Local Processor” display shows input, output, and wideband/multiband meters for the processor used by the internal player and the optional local insertion audio source.



- ◆ The “I/O Meters” display shows the levels of all input audio sources and all physical outputs.

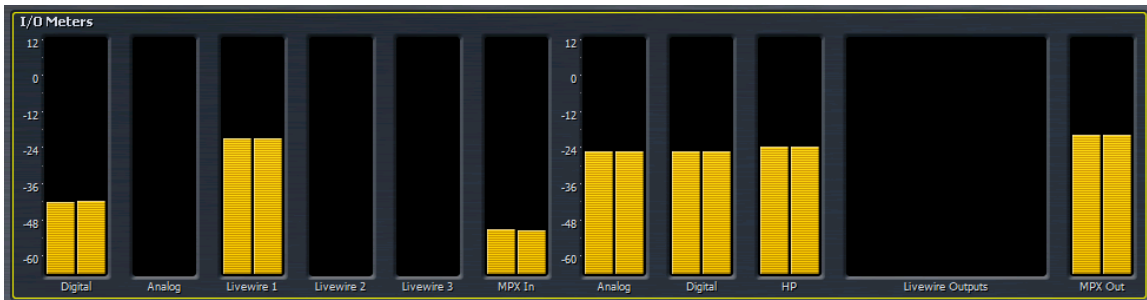

Loudness Meters

ITU-R BS.1770 loudness meters and graphs can be displayed from this menu.

- ◆ The “Loudness Meters” display shows a bar graph and a numeric LKFS loudness value for the pre-final input, the input of the local processor, the composite (MPX) output, and both composite inputs.

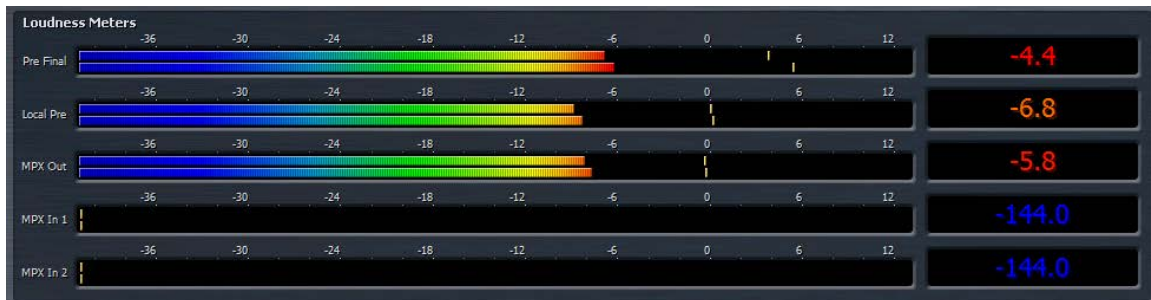

- ◆ The “Short Term Loudness” graph can show recent loudness measurements over time; the exact length of time will vary depending upon display size, with longer periods of time being available with more space. This is further adjustable by the “X Range” control. The “History” control can be used to look at data recorded further back in time than can be displayed in the current scrolling window.

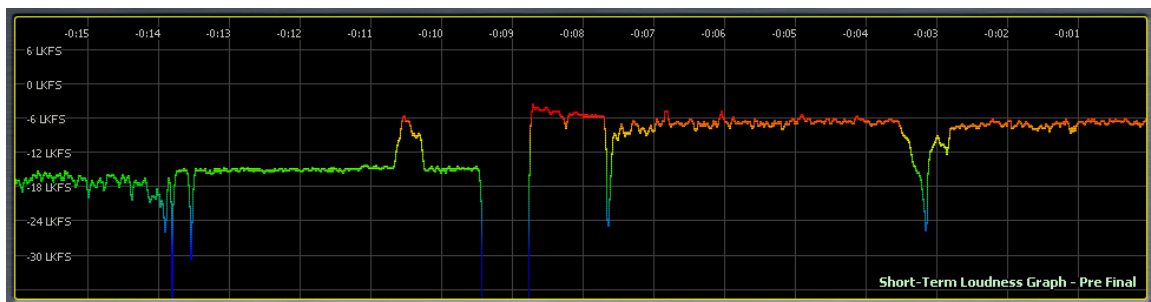

The graph can measure pre-final input audio levels, local processor input levels, MPX output levels, or the inputs of either rear panel composite input. Adjustments to the Y-axis are provided should it be necessary to shift or zoom to better read the graph in greater detail. The “Time” menu is set to “Relative” by default (showing the elapsed time relative to the present) but can be changed to an actual time value if desired. “Local” references the internal clock of Omnia.9sg. “Remote” references the internal clock of the PC running the NfRemote session. “UTC” is true universal time with no local offset applied.

- ◆ The “Momentary Loudness” graph works in exactly the same way as the “Short Term Loudness” version but provides a more detailed view over a much shorter period of time.

Modulation Monitor

Omnia.9sg can display modulation information in a numeric form, on bar graph meters, and, when using the MPX Power Limiter, a power graph. Exactly which values are displayed in any of these formats is determined by the settings in the “Meter Options” menu which are covered in greater detail in the “Meter Options” chapter.

- ◆ The “Numeric Modulation” display can show MPX Power, total modulation, L/R modulation, and pilot levels as a numeric value.

Source	Power	Mod	Pilot	L/R De-mod
MPX Out	+6.7	101	8.9	133 134
MPX In 1	-144	0	0.0	0 0
MPX In 2	-144	0	0.0	0 0

- ◆ The “MPX Power Graph” display shows loudness trends over time and operates in much the same way as the loudness graphs described in the “Loudness Meters” section above.

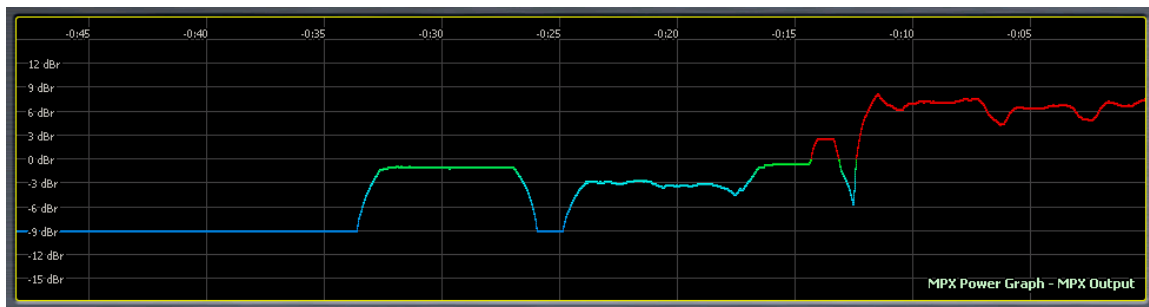

- ◆ The “Modulation Meters” display can show all of the same information as the “Numeric Modulation” display, but with bar graph meters.

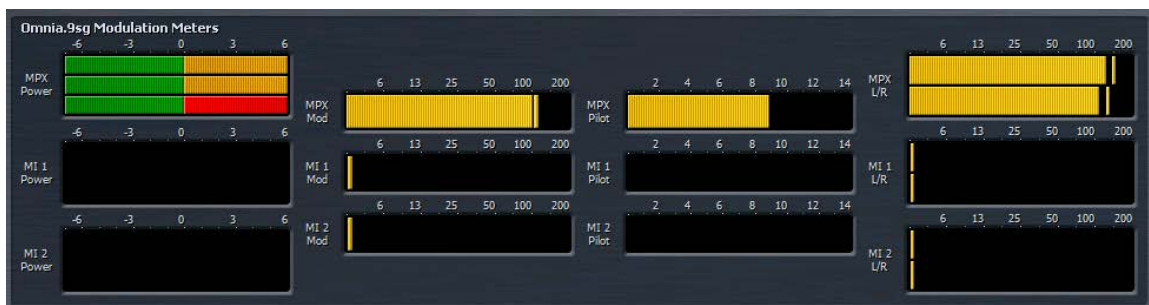

Instrumentation

Information about the action of the clipper as well as details about the audio signal from various patch points within Omnia.9sg via an oscilloscope, FFT spectrum analyzer, and RTA are available from this menu.

- ◆ The “Oscilloscope” display brings up the controls and various patch points for the built in digital, over-sampled oscilloscope. While you’ll find many of the same controls as a typical ‘scope such as gain and zoom, ours has a few “extra” tricks up its sleeve like adjustable limit lines and phosphor persistence. Selecting the patchpoint of interest via the well-labeled menus and sub-menus should be fairly self-explanatory.

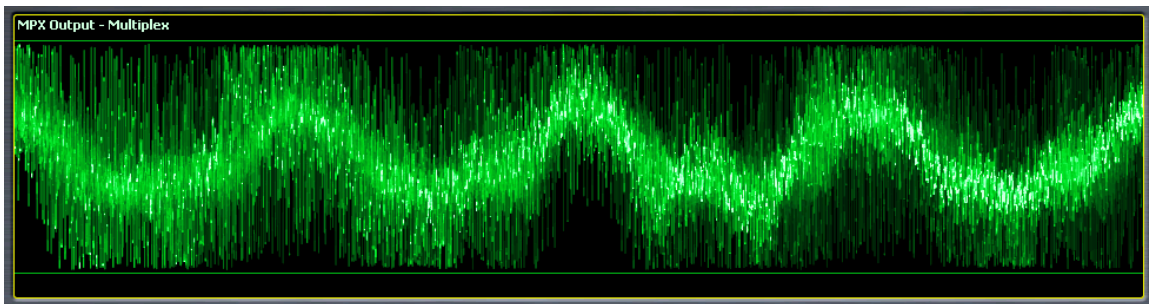

- ◆ The “RTA” display provides a 1/3 or 1/6 octave real time analyzer, a useful tool for showing overall “shape” of the audio from various patch points.

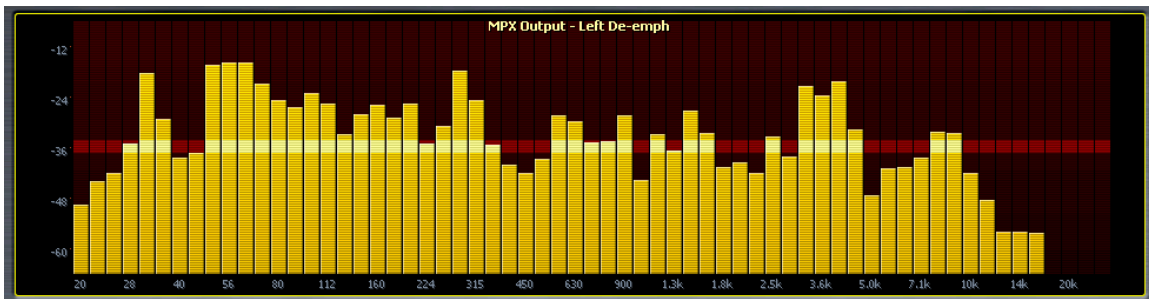

- ◆ The “FFT Spectrum Analyzer” provides a wealth of information about the audio and composite (MPX) signals throughout the processing chain. Especially useful is the multiplexed composite output display which gives a detailed view of upper and lower sidebands, the pilot, and the RDS signal.

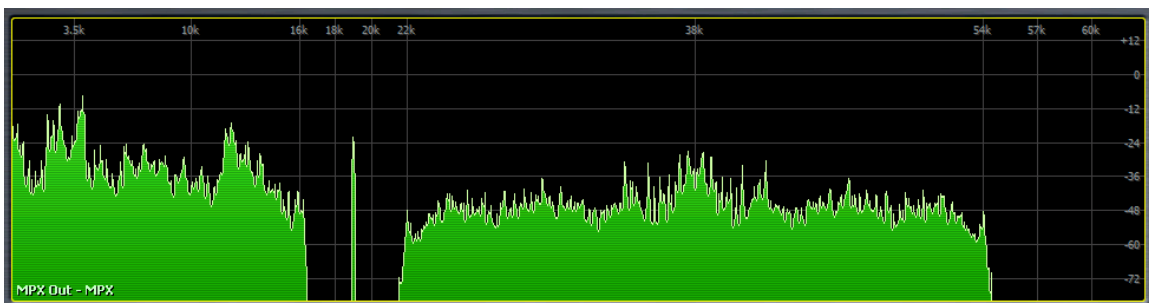

- ◆ The “Clipper” display shows the clipping action and depth of both the main and the bass clipper.

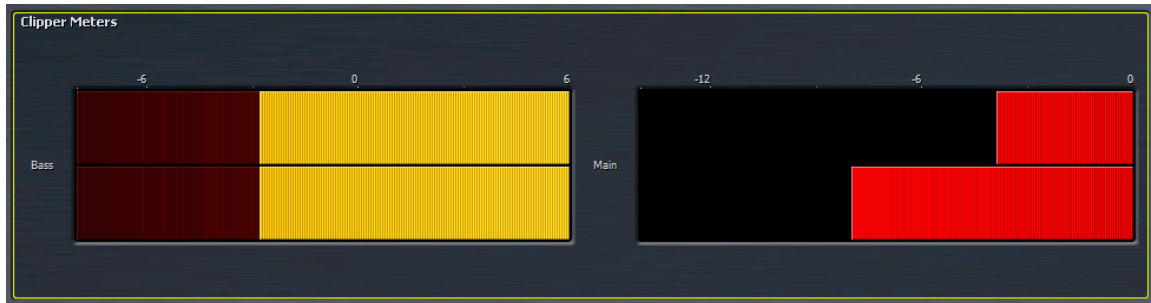

- ◆ The “Client Audio” feature will be explained in greater detail in a later chapter, but for now, it is sufficient to just be aware that its output levels and protection limiter activity can be viewed in the display windows if desired.

MPX Inputs Menu



Omnia.9sg offers two rear panel composite (MPX) inputs which can be used to feed the output of an external RDS generator, the composite output of another processor, or the composite output of a tuner or frequency-agile modulation monitor.

These inputs can also be used for inserting 67 and 92kHz audio or data SCAs as well as a DARC (Data Radio Channel) sub-carrier.

The controls for both MPX Input 1 and MPX Input 2 are identical.

MPX Input 1/MPX Input 2 Menus

Controls to adjust the input gain, source pre-emphasis, delay, equalization, and tilt are offered.

- ◆ “Input Gain” sets the input level of the MPX input.
- ◆ The setting of the “Source Pre-emphasis” control determines the amount of de-emphasis (if any) applied when the MPX input signal is selected as a source in a display window or auditioned in one of the monitor output patch points. Typically, it should match the pre-emphasis of the incoming composite signal.

- ◆ The “Add Delay” control allows the audio being fed to the MPX input to be delayed to match the latency of Omnia.9sg.
- ◆ Enabling the “PEQ” button turns on the 2-band parametric equalizer. The center frequency, width, and gain controls work in the traditional manner, while the “Phase” control offers a choice of phase linear, phase forward, or phase reverse equalization.
- ◆ The output of most mod monitors and tuners have some tilt present, for which the “Tilt Amount” and “Tilt Coefficient” controls can compensate.
- ◆ After correcting for tilt, it is still possible to have some DC offset remaining due to differences in infrasonic frequency between the tilt control and the material that caused the tilt in the first place. The “DC Servo” control can be used to compensate for this, but because it moves the entire waveform it technically invalidates the initial measurement and “fixes” the problem even if it originated in the transmitter. Accordingly, it should be used with caution.
- ◆ Choosing “Peak-based” provides the most accurate compensation but should be used only if the incoming signal is pristine as any noise may be misinterpreted as an actual audio peak. “Average-based” sacrifices some accuracy but is more tolerant of noisier signals.

Local Processor Menu



In its role as a standalone stereo generator, Omnia.9sg will be ordinarily fed pre-processed audio and be responsible only for final clipping and creating the composite signal.

However, since it has an internal player to provide audio should the primary and/or secondary signals go away and can optionally insert local audio into the final clipper, built-in audio processing for these sources is provided.

The basic processing architecture and algorithms are nearly identical to those in our Omnia.7 and Omnia.9 processors, but more basic in nature. Included are downward expanders, an input AGC, a second wideband AGC, a four-band parametric equalizer, a multiband stereo enhancer, two, three or four bands of multiband AGC and limiting, a band mix output control, and clipper settings with identical controls to those found in the main section of Omnia.9sg, but used only when the internal processing is active.

As with Omnia.7 and Omnia.9, factory presets load at a basic adjustment level. In the majority of cases these adjustments provide all the control needed for the most common tweaks and modifications to achieve a desired sound or loudness level.

Descriptions of the basic processing controls in this manual will be kept deliberately brief as it is expected that the built-in processing will be used only in emergency situations (for the internal player) or for limited content insertion (for the optional local audio insertion feature).

An explanation of the hundreds of controls found in the Intermediate and Advanced adjustment levels will not be provided here. Should you feel the need to modify a factory preset to that degree and need per-control information, it can be found in either the latest Omnia.7 or Omnia.9 manual at TelosAlliance.com/Omnia/Omnia9sg.

Load Preset Menu



The “Load Preset” menu allows you view the preset currently on the air, toggle back and forth between the current and backup presets, load a new preset, compare the settings of two presets, and delete user presets.

Changing any parameter of a preset will cause a modified flag (“M”) to appear next to the preset name indicating that it has been changed but not saved as a unique preset.

Save Preset Menu



The “Save Preset” menu allows you save a modified version of an existing preset and give it a unique name. Once saved, this preset will show up in the list of available presets but in yellow, indicating that it is a user preset. Factory presets are white.

Preset Protection Menu

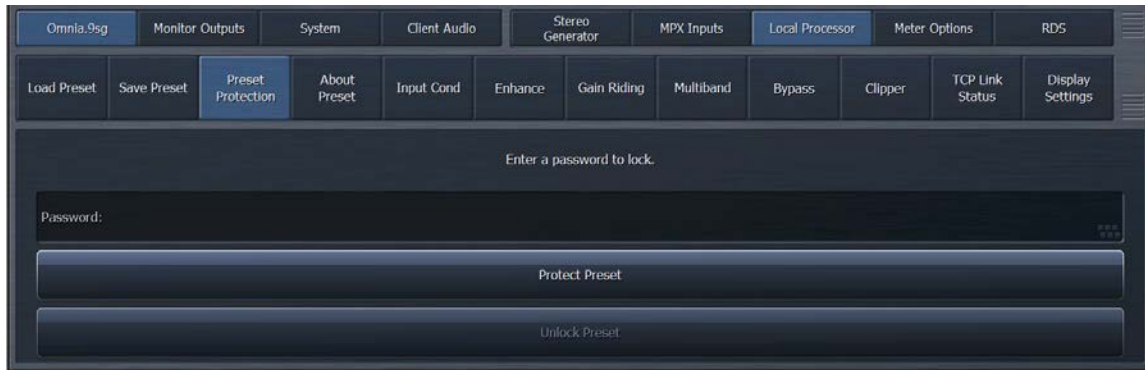

Presets can be password protected to prevent any modification. It also prevents them from being copied for use in another Omnia.9sg. Settings for protected presets will be hidden from view as long as the preset is locked. Enter the desired password, follow on-screen verification prompts, enter a unique name for the protected preset, and save it. Remember not to leave the unencrypted version of your preset loaded in the “Backup Preset” slot!

About Preset Menu



The “About Preset” menu contains information about the current preset including its current adjustment level (Basic, Intermediate, Expert), its author, and a description of its characteristics.

Input Conditioning Menu



The “Input Conditioning” menu contains the controls for the multiband downward expanders which can be helpful for managing noisy content (such as tape hiss on old recordings) or environmental noise (such as HVAC noise).

- ◆ The “Noise Reduction Amount” slider controls the maximum amount of downward expansion.
- ◆ The “Noise Reduction Threshold” control determines the point at which the expanders begin to react.

Enhance Menu



- ◆ The “Enhance” menu provides control over the spectral balance of the processed audio as well as the amount of stereo enhancement.
- ◆ With 4 band presets, “Deep Bass” control makes simultaneous adjustments to several individual controls including the lowest band of the parametric equalizer, the target level of Band 1 in the multiband AGC, and the setting of the Band 1 Band Mix control. In 2 or 3 band presets, only the parametric EQ is adjusted.
- ◆ The “Warmth” control works in the same manner as “Deep Bass” but operates on the mid-bass and low-mid range of frequencies. In 2 or 3 band presets, only the parametric EQ is adjusted. With 4 band presets, the target setting of Band 2 in the multiband AGC and the output level of Band 2 in the Band Mix controls are also adjusted.

- ◆ The “Presence” control adjusts high-mid frequencies and adjusts only the parametric EQ regardless of the number of bands of multiband processing employed.
- ◆ The “Brilliance” control adjusts the high frequencies. In 2 and 3 band presets, only the parametric EQ is adjusted. In 4 band presets, the target setting of Band 4 in the multiband AGC and the output level of Band 4 in the Band Mix controls are also adjusted.
- ◆ The “Stereo Enhancer” control turns the multiband stereo enhancer on or off. The total amount of stereo enhancement is adjustable via the “Stereo Amount” control.

Gain Riding Menu

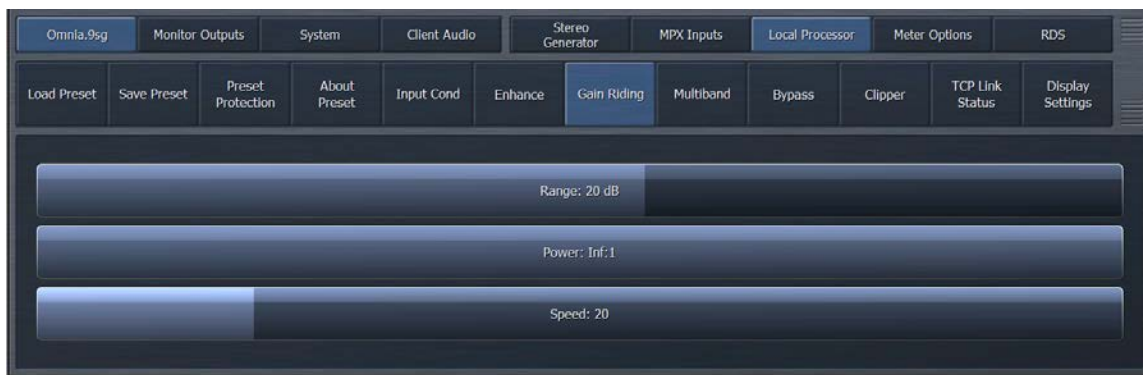

The behavior of the wideband AGC’s (Input AGC and Wideband AGC) is determined by the settings of the controls in this menu.

- ◆ The setting of the “Gain Riding Range” control affects only the Input AGC and determines the amount of available gain. Setting this control too high may provide too much room for low level audio to be raised up while not providing enough room to adequately attenuate higher input levels. Conversely, setting it too low may not provide enough gain to increase low incoming levels.
- ◆ The “Power” control simultaneously adjusts the ratio of both the Input AGC and the Wideband AGC. Advancing the control tightens the ratio and provides more consistency with varying input levels. Moving the control to the left loosens the ratio and yields a more open sound.
- ◆ The “Speed” control simultaneously adjusts the attack and release rates of both the Input AGC and Wideband AGC. Higher settings translate to faster attack and release rates, but because the actual attack and release speeds are program dependent, the numeric value on the control is for relative use only and simply represents the position of the slider (0 = control completely to the left, 100 = control completely to the right).

Multiband Menu



The controls in the “Multiband” menu work much like their counterparts in the “Gain Riding” menu (as the sharper students in the class may have already surmised) but affect the multiband AGGs.

Bypass Menu



Enabling the “Bypass Processing” button bypasses all dynamics processing. The “Bypass Gain” control should be set so that the level of unprocessed (bypassed) audio matches the average level of process audio as closely as possible.

Clipper Menu

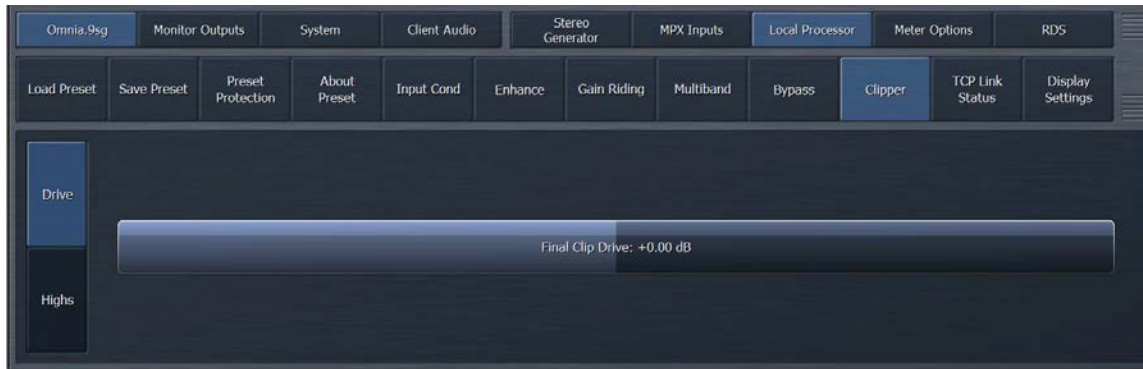

In most cases, it will be desirable to select and/or modify one of the presets in the built-in processor to match the texture and loudness of the main processor as closely as possible, but since Omnia.9sg can be fed from any processor, there will be differences. Accordingly, the clipper settings in Omnia.9sg will need to be different when using the internal processor, so individual controls are provided here. These settings are only used when the internal processor is active, that is when the source audio is being provided by the internal player or (optionally) via the local audio insertion path.

Drive Menu

- ◆ In the basic adjustment mode, a single “Final Clip Drive” slider controls the overall amount of clipping.

Highs Menu

These controls affect the sound and texture of middle and higher frequencies.

- ◆ Enabling the “Sparkling Highs” control preserves the openness and enhances the texture of very high frequencies, especially when the incoming program material has a high degree of high frequency content.
- ◆ “Phat Mids” warms up and enhances mid-range frequencies, particularly male and lower female voices. Please note that “Sparkling Highs” must be enabled for “Phat Mids” to be selectable; if “Phat Mids” is enabled and “Sparkling Highs” is turned off, the “Phat Mids” indicator will remain yellow and switch back on when “Sparkling Highs” is re-enabled, but will be grayed out and removed from the audio path until such time.
- ◆ The “High Frequency Edge” control sets tradeoff between highs that are always clean and free from distortion and a consistent high frequency output at the expense of distortion. A setting of “0” will yield the cleanest highs but with less overall brightness. A setting of “100” will result in a uniformly bright sound but at the risk of more audible distortion, and sounds more like the original Omnia.9 clipper when pushed for loudness.

Please note that the “Lows” menu and the controls it contains are only available in the Intermediate and Expert adjustment levels.

Meter Options Menu



Exactly which meters appear in the Loudness Meter, Modulation Meter, and Modulation Numeric display windows is determined by enabling or disabling various options in this menu. If you do not see a meter you expect to see in any of the graphs or meters, check this menu to ensure the one you are looking for has been enabled.

The following is a list of which meters are available in each window:

- ◆ “Pre-final” and “Local Pre” are available in the Loudness Meter display
- ◆ “MPX Output”, “MPX Input 1”, and “MPX Input 2” are available in the Loudness Meter, Modulation Meter, and Modulation Numeric displays
- ◆ “MPX Power Graph” is available only in the MPX Power Graph display
- ◆ “Loudness Graph” is available in both the Short Term and Momentary Loudness displays
- ◆ “MPX Power Meter”, “Peak Modulation Meter”, “Pilot Level Meter”, and “L/R Level Meter” are viewable only in the Modulation Meters display
- ◆ “MPX Power Numeric”, “Peak Modulation Numeric”, “Pilot Level Numeric”, and “L/R Level Numeric” are available only in the Modulation Numeric display

The “MPX Power Limit” slider is normally adjusted to the same value as the MPX Power Limit control in the Stereo Generator menu. It is responsible for controlling the color of the MPX Power Graph, the color of the Power readout in the Modulation Numeric display, and the color and scale of the Power display. The responsiveness of the Power Limiter meter in the Pre-final Meter display window can be adjusted with the “Peak Response Time” control.

RDS Menu

Omnia.9sg has a full-featured built-in RDS encoder and also supports the use of external encoders through its dual MPX inputs. A pilot signal is not required from external encoders as Omnia.9sg will always use its own internal reference to generate RDS even if the pilot is disabled during mono programming. Please note that the MPX inputs cannot be used to insert an SCA signal.

RDS Main Menu

Controls for turning RDS on and off and for selecting between the internal and an external RDS generator are located here, as is the slider to control the injection amount. UECP information can be added here as well.

Main Sub-Menu



- ◆ The “RDS Mode” control turns off RDS altogether or selects between the internal RDS generator and an external generator.
- ◆ When RDS is enabled, the “Injection Level” control adjusts the percentage of data injection.

Current PS, RT, and Time information are also displayed.

UECP Sub-Menu



UECP (Universal Encoder Communications Protocol) is a standardized protocol for communicating with RDS encoders and provides the ability to address all encoders, specific groups of encoders, or individual encoders. This is particularly useful in non-U.S. applications where the use of RDS is more highly developed and embraced and where identical content is broadcast from multiple geographically-diverse transmitter sites.

- ◆ The “Use UECP” button enables/disables UECP. Enabling UECP will utilize data coming in from the automation system or other external data source in lieu of any internal settings.
- ◆ The “UECP” field is used to specify the IP port on which UECP RDS data is received.
- ◆ Clicking on the “Update UECP” button will confirm the port entry made above or update it if changed.
- ◆ Enabling “Use Internal Settings on Connection Drop” will utilize any data entered into the internal RDS fields when if the connection to the external data source is lost. When the connection is re-established, the data from the external source will once again be applied.
- ◆ As UECP supports very granular addressing of RDS traffic, data can be targeted to reach a particular transmitter site (s) or even a particular RDS encoder (s) . Enabling “Listen to Specific Address” and entering the Site Address AND Encoder Address in their respective fields will allow Omnia.9sg’s RDS encoder to receive this specific information.
- ◆ The “DSN” (Data Set Number) and “PSN” (Program Service Number) fields can optionally be used to further narrow down and filter applied information from the data source.

RDS Station ID Menu

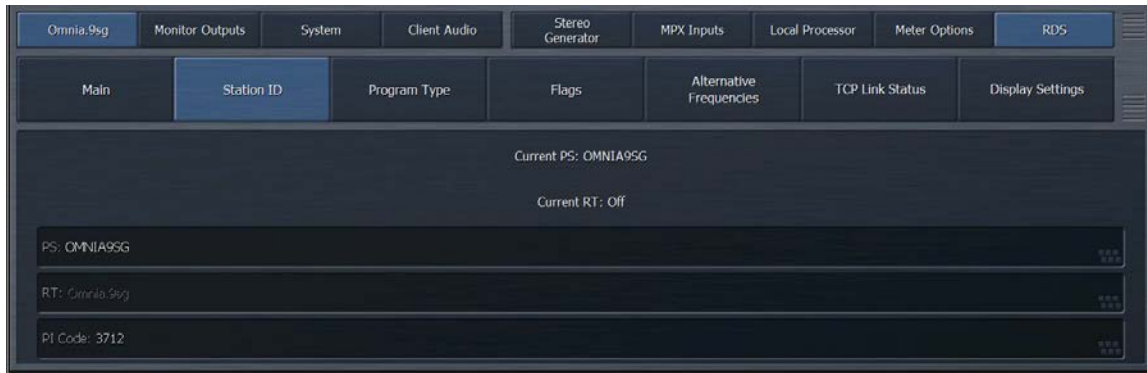

This menu provides fields for entering Program Service (PS) and Radio Text (RT) information as well as the Program Information (PI) Code.

- ◆ Normally the “PS” field is used as an 8-character static display and contains the station’s call letters, but it is possible to program it to provide additional information such as title and artist, or station slogan. This field can optionally be updated dynamically by an automation system via the http interface or UECP.
- ◆ By splitting text with the “/” symbol, each text block will alternate for 3 seconds – for example, “WOMN-FM/88.5 FM/CLASSIC/ROCK”.
- ◆ To change the amount of time each text block is displayed, enter the desired time in front of the text in seconds – for example, “1.5sWOMN-FM/1.5s88.5 FM/1.0sCLAS-SIC/1.0sROCK”.
- ◆ The “RT” field provides space for a 64-character free-form message that many radios will display in addition to the PS field, either automatically or on demand. Like the PS, it can be a static field (to provide a station slogan for instance) or dynamic (to provide song title and artist information) . Dynamic updating is accomplished through the http automation interface or UECP. This field will be greyed out unless “RadioText” is enabled in the “Flags” menu described later in this chapter.
- ◆ The “PI Code” field is a hexadecimal number that normally corresponds to your station’s call letters. A handy PI code translator can be found at <http://www.w9wi.com/articles/rdsreverse.htm>. Remember to use the HEXADECIMAL result.

Program Type Menu



Controls for choosing the RDS mode (USA or Europe), enabling Dynamic Program Type (PTY), and choosing a PTY code are located here.

- ◆ Choose “RDS” (for European applications) or “RBDS” (for U.S. use) in the mode drop-down menu.
- ◆ When enabled, “Dynamic PTY” indicates to listeners that the type of programming on your station may change periodically, for instance, music during the week but sports on the weekends. The PTY code can optionally be updated by your station’s automation system via the 9sg http interface.
- ◆ The “PTY Code” list provides a choice of the 31 standard program formats for static selection, and will reflect any changes made via the http automation interface if dynamic PTY is used.

Flags Menu



Enable/disable buttons for standard RDS “flags” are found here.

- ◆ When the “Radio Text” button is enabled, whatever information has been entered into the “RT Field” in the RDS Station ID menu will be displayed. Note that the RT field will be greyed out unless this flag is enabled.
- ◆ The “Traffic Program” (TP) flag allows listeners to find stations that regularly broadcast traffic bulletins. This flag would generally be used in connection with the “Traffic Announcement” (TA) flag described below.

- ◆ When enabled, the “Time Code” (CT-Clock Time) flag will broadcast the system time from 9sg via the RDS subcarrier. If you choose to enable this feature, be SURE your 9sg is synced to a reliable source of NTP time (System > Time/Date > NTP > NTP Synchronization). Failure to do this WILL lead to listener complaints as their radios change their clocks when they tune to your station.
- ◆ Enabling the “Compressed” decoder information control to indicate the audio has been processed, though most modern RDS receivers simply ignore this control as its use and acceptance have become uncommon.
- ◆ The “Stereo” decoder information control identifies the station as broadcasting in stereo.
- ◆ The “Music” decoder information control identifies the station as one that offers primarily music content (as opposed to talk or speech) which in turn allows certain receivers to alter the volume for differing content. It can be turned on and off as programming changes through a request to the built-in http server.
- ◆ The “Artificial Head” decoder information control – also now rarely used – indicates the use of a binaural microphone.
- ◆ When enabled, the “Traffic Announcement” (TA) flag (on certain receivers) can actually stop the playback of non-broadcast media such as a CD or auxiliary audio input and tune into a broadcast station when a traffic bulletin is received. This command would typically be automated through the http server and used in conjunction with the “Traffic Program” (TP) flag described earlier.

Alternative Frequencies Menu



Broadcasters who offer the same programming on multiple frequencies can take advantage of an RDS receiver’s ability to search for and tune into up to 16 alternative frequencies when the signal of the current frequency weakens. The “Alt Freq 1” and “Alt Freq 2” menus allow you to specify those frequencies. Use this feature with caution as it may not be consistently implemented on different receivers. Typically, it would be used in very large networks with overlapping transmitters on the same groups of frequencies.

4 Monitor Outputs

Omnia.9sg offers three monitor outputs – “Headphone”, “Speaker”, and “Aux” – which can be used to take audio from a particular physical input or from various soft patch points within the audio path and route that audio to a particular destination. These destinations can include a physical output (such as the rear panel AES output or front panel headphone output to aurally monitor the audio) or an instrument display such as the oscilloscope, FFT spectrum analyzer, or RTA.

The “Headphone” monitor output is unique among the three outputs in that its output is hard wired to the front panel headphone jack. The “Speaker” and “Aux” monitor outputs are identical in everything but name, and can be soft routed as described above.

The concept and function of the monitor outputs can be confusing, but it helps to keep these two points in mind:

- ◆ The INPUT to the monitor output – that is, the source audio that can potentially feed a physical output or a display – is set in the in the “Patch Point” menu (described in greater detail below) here in the Monitor Outputs menu.
- ◆ The OUTPUT of the monitor output – that is, the audio from the selected patchpoint – can be picked up as a source in various places throughout the system, including the headphone jack, AES output on the rear panel, or in the Display Settings menu under the “Instruments” menu.

As the menu structure and controls for all three outputs are identical, the following information applies across the board (including “Client Audio”, described in a later chapter).

Headphone/Speaker/Aux Output Menu



This sub-menu broadly categorizes the various input types available for monitoring. It contains sub-menus of its own for selecting the patch point, loading and saving monitor presets, as well as monitor-specific gain and EQ controls. These sub-menus are identical in terms of the controls that are offered. The only difference is in which monitoring path is being adjusted.

Patch Point Menu



Three audio input sources are presented here – “I/O”, “Physical Inputs”, and “MPX Decoded”.

I/O Menu

“Pre-final” represents the main audio source at the input of the clipper. “Local Processed” is the output of the built-in processor which can be fed from either the internal player or from the local audio insertion source. “Local Pre” is the input to the internal processor. “MPX Input 1” and “MPX Input 2” correlate to the output audio of any device connected to the composite inputs. A full composite output signal of Omnia.9sg itself is also available by selecting “MPX Output”.

Physical Inputs Menu

Audio from either the rear panel AES Digital input or Analog input is offered here.

MPX Decoded Menu

Decoded (pre-emphasized/de-emphasized) audio can be monitored here from either Omnia.9sg’s own composite generator via the “MPX Output Decoded” option, or from either of the composite inputs via “MPX Input 1 Decoded” and “MPX Input 2 Decoded” buttons.

Load Preset Menu



Because Omnia.9sg (along with the “Client Audio” feature built into NfRemote) provides all of the tools – minus a calibrated microphone – to perform speaker/room calibrations for each Monitor Output, it also provides a means by which to store those calibrations for later recall in the form of presets.

Remember that these are NOT the same as your on-air processing presets! These affect ONLY the Monitor Outputs. The menus and controls, however, operate in exactly the same way.

- ◆ The “Current Preset” window shows the preset currently in use.
- ◆ Clicking on the “Recall Backup” button will place the preset listed into the “current” location, allowing you to toggle back and forth between two presets.
- ◆ Clicking on the “Diff Preset” button allows you to view differences between the current and backup preset, providing neither have been modified and not saved. Control settings from the current preset that are different from the backup preset will be displayed in yellow.
- ◆ The “Delete Preset” button does exactly that: Deletes the current preset. It will remain the current preset until another preset is recalled, but will no longer be available for recall once another preset replaces it.
- ◆ The “Load From” button allows a preset saved to the PC running NfRemote to be loaded into the Omnia.9sg. This is handy for uploading a configuration saved to that PC from another unit. Remember that “Load From” immediately loads the preset into the current preset slot, and that the preset must be saved on the Omnia.9sg itself from the “Save Preset” menu in order to be available from the list of presets to the right of the controls.

Save Preset Menu



The menus and controls here work the same way as their counterparts elsewhere in the menus.

- ◆ Clicking on “Save Preset” after typing the name of your choosing into the text field will create a preset which can later be recalled from the list on the right side of the screen.
- ◆ The “Save to PC” button saves the preset file to the location of your choice on your PC so that it can be shared or uploaded to other Omnia.9sg units.

Main Menu

The “Main Menu” contains five sub-menus with their own sets of controls which are used for room and speaker calibration.

While the 9sg is somewhat unique in that the speaker calibration controls would not typically be used for the same purpose they are on Omnia.9 (setting your processing) it can still be useful to create a calibrated monitoring reference when you are using the 9sg with OTHER processing that does not include the extensive built-in monitoring and test instrumentation provided by 9 and 9sg.

Main Menu (No, this is not a typo—we liked it so much we put it there twice!)



The “Main Menu” contains basic gain controls to set the output levels of each Monitor Output when creating a calibration profile.

- ◆ The “Volume” slider adjusts the output level to the the specified Monitor Output.
- ◆ Enabling the “Bypass” control removes any parametric EQ settings, loudness contours, or high pass filtering from the Monitor Output.
- ◆ Enabling the “Lock” control will gray out all controls in this menu to prevent them from accidentally being changed or tampered with and prevents any other users remotely connected to the unit from changing the selected patch point.
- ◆ The “Pink Noise” controls enable/disable the built-in pink noise generator per channel (left or right).
- ◆ Each Monitor Output contains protection limiters which are useful as speaker calibrations are typically done at higher volume levels and can involve radical amounts of parametric equalization in the pursuit of a flat frequency response. When these limiters are active, you will notice orange bars extending from the corresponding volume control sliders. When this occurs, use the “Master Gain” control to attenuate the overall gain and prevent the limiters from stepping in. If you have made significant cuts to particular frequencies, you may need to raise the “Master Gain” control so that the output level more closely matches that of the original, un-calibrated output – especially useful when “A/B-ing” the audio with the “Bypass” control.
- ◆ The “Left Level” and “Right Level” controls allow the gain to be adjusted independently in each channel and act as a “balance control” in situations where the left and right speakers are not equally spaced from the monitor point.

- ◆ The “Bypass Gain” control adjusts the output gain when the “Bypass” control is enabled. Individual left/right controls are provided here as well.
- ◆ The “Solo” controls allow only one channel at a time to be monitored.

X-Over Menu



The “Main Menu” contains controls that allow high-pass and low-pass filter frequencies to be set and also permit different high pass filtering depending upon the setting of the “Volume” control. This can compensate for systems that have an uneven frequency boost applied to make them sound better at low volumes which does not scale appropriately with increased volume.

- ◆ Enabling the “Volume-based High Pass Filter” enables or disables this feature. The main high pass and low pass filters on the right half of this screen are still active unless set to “Off”.
- ◆ The “Volume” control is a duplicate of that found in the “Main” menu placed here for convenience. Monitor protection limiter activity (described earlier) will be displayed in this control.
- ◆ Two sets of “@ Volume” and “High pass filter” controls are provided to customize the threshold and shape of the volume-based high pass filter.
- ◆ The volume-based high pass filter sliders set the lowest frequencies permitted to pass through the Monitor Output once the thresholds set in the “@ Volume” sliders are crossed. If the “@ Volume” slider is set to “0”, that volume-based high pass filter will be active at all volume levels. The default and lowest value (unless disabled) is 15 Hz.
- ◆ The two sets of volume-based high pass filter controls interact. If, for example, the first “High pass filter” control is set to 135Hz with the associated “@ Volume” control set to -35dB and the “Volume” is control set at 0.0dB, the filter will be set at 15 Hz, which is the default frequency of the 2nd volume-based high pass filter control.
- ◆ As the “Volume” level is decreased you will see the high pass filter frequency begin to rise. By the time it gets to -35dB – the threshold set by the first “@ Volume” - it will high pass at 135Hz, the frequency set in the first volume-based high pass filter control.
- ◆ In addition to the volume-based high pass filters, there are also fixed frequency high and low pass filters for both left and right channels. These can be linked in the “Channel Coupling” menu described below.

Delay, Phase Menu



This menu allows setting delays on the left channel, right channel, or both. Along with the individual channel volume controls described earlier, this can compensate for monitors that are not equally spaced, which would result in slightly different arrival times for the audio from each monitor speaker. Controls are provided to completely invert the polarity of either the left or right channel as well. This can compensate for mis-wired cabling resulting in one monitor channel 180 degrees out of phase with the other (though it would probably be a good idea to fix such an egregious wiring error). A “Defeat Delay” control is also provided to bypass this delay entirely.

Channel Coupling Menu

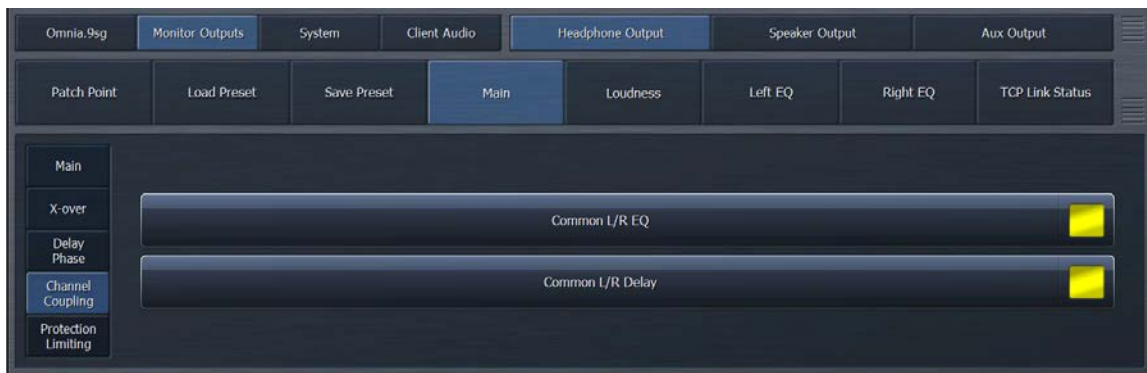

In some installations, the left and right speakers are in similar locations within the room and relative to the monitoring point. In these situations, EQ and Delay settings can be applied to both channels by enabling the “Common L/R EQ” and “Common L/R Delay” controls.

Doing so grays out the right channel controls in the “X-Over” and “Delay Phase” menus and allows the left channel controls to act as a master for both left and right channel adjustments.

Protection Limiting Menu

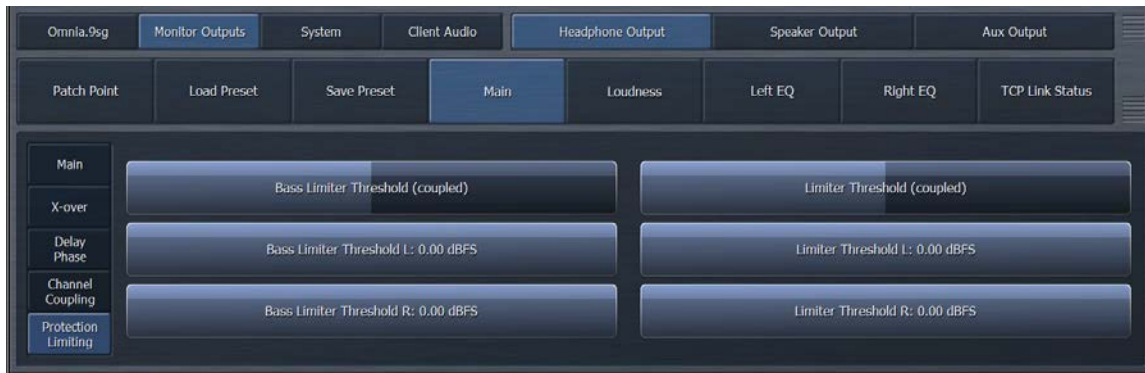

As previously mentioned, each Monitor Output employs limiters to keep the outputs from distorting when large amounts of EQ are applied which is often necessary during calibration.

- ◆ The “Bass Limiter Threshold” sets the point at which the bass limiters engage, especially useful when pushing large amounts of bass through smaller speakers. The “Coupled” control moves both the right and left controls simultaneously.
- ◆ The “Limiter Threshold” sets the threshold of the final protection limiters in each Monitor Output. They too have a “Coupled” control.

Loudness Menu



The audio monitoring tools in 9sg also include a loudness curve adjustment. These controls (much like the “Volume-Based High Pass Filter” mentioned earlier) can compensate for monitoring systems with an uneven frequency response that varies based on the volume. There are 6 bands of control available (displayed in groups of 2) and all function identically.

- ◆ The “Volume” control functions identically to the other monitor volume controls located throughout the interface and is coupled to those controls.
- ◆ The “Loudness” button enables or disables these loudness controls.
- ◆ “Band x Minimum @ x dB” interacts with the “Band x Maximum @ x dB” control and determines the point on the monitor volume control at which the gain of this band is 0 dB.

- ◆ “Band x Maximum @ x dB” interacts with the “Band x Minimum @ x dB” control and determines the point on the monitor volume control at which the gain of this band is the amount set by the “Band x PEQ Gain” control.
- ◆ Note that this “Minimum” and “Maximum” is relative to 0 dB regardless of the sign. A “Maximum” could be -2 dB or + 2 dB (for example) depending on whether the PEQ Gain for that band is set to cut or boost.
- ◆ “Band x PEQ Center Frequency” (as one would expect) determines the center frequency of each EQ band. Note that each band can be set to any frequency (or the same frequency) and they do not necessarily need to be in order by frequency. This is truly a fully parametric EQ.
- ◆ “Band x PEQ Bandwidth” controls the bandwidth or “Shape” of the EQ curve for each band. Lower numbers will create a narrower EQ curve and affect a smaller number of frequencies near the center, while larger numbers will create a broader EQ curve and affect a wider range of frequencies further away from the center.
- ◆ “Band x PEQ Gain” controls the maximum boost or cut for each EQ band and interacts with the “Band x Maximum @ x dB” control above.
- ◆ A value for the currently applied boost or cut in each band is displayed below each set of EQ controls.

Left/Right EQ Menu

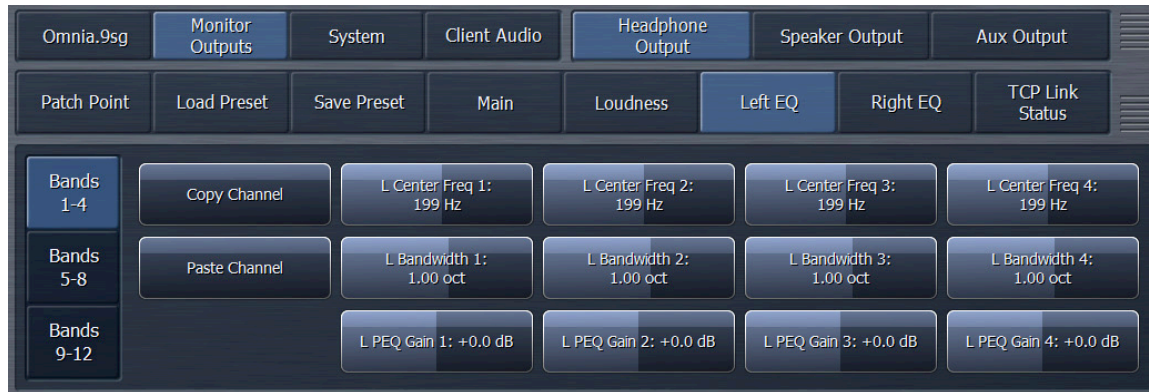

Following the main monitor controls (x-over, delay/phase, loudness) is another fully parametric EQ for “fixed” frequency response tuning of the monitor system, not based on the monitor volume level. There are 12 bands of EQ available (displayed in groups of 4).

With the exception of the fact that these are fixed gain levels rather than tied to the monitor volume control, these EQ bands function identically to the loudness EQ controls described above (center frequency, bandwidth, gain).

If the “Common L/R EQ” setting is selected in the “Channel Coupling” menu described earlier, the “Right EQ” settings will be greyed out and will follow the “Left EQ” settings.

When the channels are not linked, Copy/Paste controls are provided to manually copy settings from one channel to the other.

5 System Settings

Monitoring and configuration of the 9sg is split into four different sub-menus under the “System” menu: “System Status”, “Scheduling”, “GPIO”, and “System Configuration”.

System Status



The “System Status” menu provides information related to the performance and configuration of 9sg. This includes details about the sample rate, up time, monitor paths, CPU load, software versions, and IP configuration.

System Information

Contains information about CPU load, available memory, up time, and software versions.

CPU Cores

Provides information on overall and per-core CPU utilization.

Network Information

This menu gives details about the unit’s LAN connection, including the IP address, MAC address, and number of NfRemote sessions that are currently connected.

Audio I/O Status

Displays information about the audio subsystem including sample rate and jitter. This is used primarily for diagnostic purposes.

Monitor Out Status (1/2)

Provides an overview of each monitor path including the currently selected source and other diagnostic metrics.

Current Alarms

Lists any current alarm conditions; also provides a brief “return to normal” status message when alarms conditions have been cleared.

Scheduling



The controls in the Scheduling menu allow you to program up to twenty-six day- and time-driven events including changing the local input mode (on units so equipped), triggering internal playback, and presets in the stereo generator, local processor, and monitor outputs. Any custom task scripts can also be executed by the scheduler.

“Events” must be disabled in order to be configured. Select the exact time and the desired days of the week for the event to fire, then choose from the list of event options in the “Function” drop down menu. Specific options will depend upon the selected function. Remember to re-enable the event!

GPI/O

Omnia.9sg supports the same functions listed in the “Scheduling” menu by way of eight traditional GPI inputs. Four additional GPIs can be triggered via Livewire. It also provides two hard-wired GPOs and four Livewire GPOs for a variety of status or warning conditions in addition to offering a logical GPI echo, physical GPI echo, plus half- and quarter-Hz test signals.

GPI Menu



GPI functionality is enabled or disabled in the “Main” tab. Please note that GPI must be disabled in order to make any GPI configuration changes.

All available hard-wired GPIs (A-H) operating in the same manner. Available parameters including any custom task scripts are available from the “Function” drop down menu.

The “Lo” and “Hi” controls work together to determine the specific action that occurs to the parameter selected in the “Function” control.

In systems employing relay logic, a contact closure from GPI to Ground is considered “engaged” and an open contact is “not engaged”.

If the signal is supplied by a 5V GPO, 0V is “engaged” and 5V is “not engaged”. A 3.3V signal will also work.

By default, the “Lo” state will stay active as long as the GPI signal is applied; once removed, the unit will return to its “Hi” state. If the “Latch” box is enabled, a momentary signal will remain active until another GPI command affecting the same function is received. The “Invert” control provides a handy way to flip-flop the “Lo” and “Hi” states and can be especially useful for testing the behavior without externally firing the command.

Pin out is as follows:

PIN	FUNCTION	PIN	FUNCTION
1	+5V, 150ma	14	+5V, 150ma
2	GPI A (Active Lo)	15	No Connection
3	GPI B (Active Lo)	16	No Connection
4	GPI C (Active Lo)	17	No Connection
5	GPI D (Active Lo)	18	No Connection
6	GPI E (Active Lo)	19	No Connection
7	GPI F (Active Lo)	20	No Connection
8	GPI G (Active Lo)	21	No Connection
9	GPI H (Active Lo)	22	No Connection
10	No Connection	23	Ground
11	Status OK	24	GPO A
12	GPO B	25	Ground
13	Ground		

GPI functionality by Livewire works in essentially the same way but without the dedicated hard-wired connection. The “IP/Port” field is used to provide the IP address and GPI port of an xNode used for remote GPI input.

GPO Menu

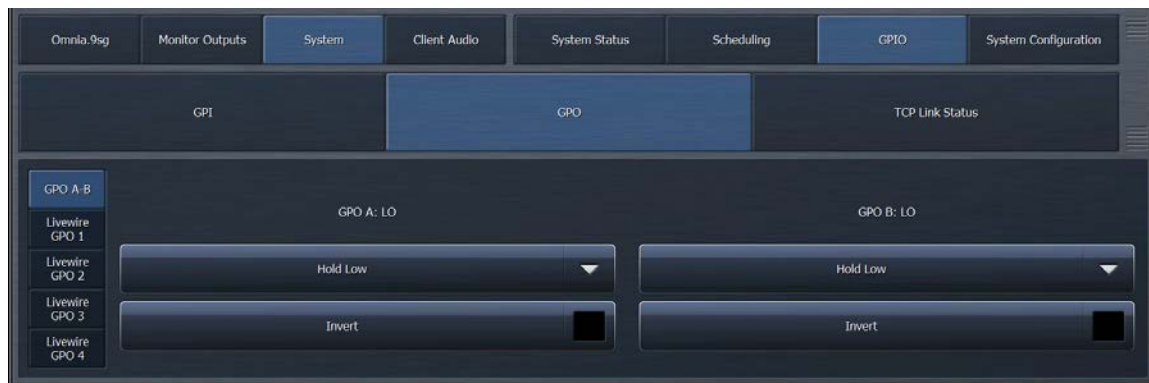

Available GPO functions can be selected from the “Hold Low” drop down menu and include several critical status or alarm conditions as well as a logical GPI echo, physical GPI echo, plus half- and quarter-Hz test signals. All GPOs will hold until the alarm situation passes and normal status resumes. By default, “Low” is considered the alarm condition (while “High” is a normal status) but this can be flipped by checking the “Invert” control.

For Livewire GPOs, the IP address of the Omnia.9sg should be entered into the “Channel” field of the xNode responsible for routing the GPO signal.

System Configuration

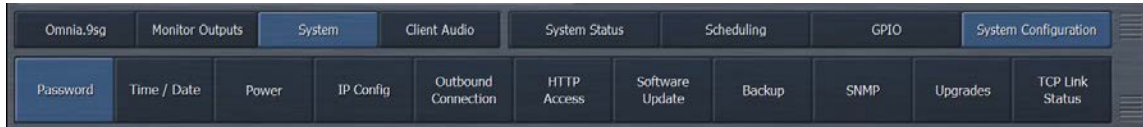

In the “System Configuration” menu you’ll find all of the “utility” controls that aren’t directly related to monitoring or MPX signal generation. This includes passwords, date/time, IP configuration, software updates, configuration backup/restore, and several other things.

Password



This one is pretty self explanatory—It allows you to change or clear the unit’s password. The default (as mentioned earlier) is 1234. We don’t recommend that you actually clear it, though it is certainly possible to do so.

Time/Date



Again, this one should be fairly self explanatory. This menu allows setting the time zone, enabling time sync via NTP servers, or setting the clock manually. We recommend that you use NTP if at all possible—particularly if you intend to broadcast time via RBDS.

The default settings for NTP server pools should be sufficient for most users, but you can also enter your own list of up to 5 NTP servers if you have specific servers on your network to which you need to synchronize.

Power



Allows a “clean” remote power cycle of 9sg. Normally this would only be necessary for troubleshooting purposes. Use this with caution as it WILL (obviously) take the 9sg off the air as it reboots. If you have an external processor connected to the MPX input, the internal relay bypass should pass signal from that audio processor through to the MPX output while the 9sg reboots. You can also “wake up” the front panel backlight remotely from this menu.

IP Configuration



This menu allows configuration of the unit’s IP address, subnet mask, gateway, and DNS servers. It also allows you to select configuration via DHCP. The currently assigned IP address is one of the first items displayed in this menu.

If “Use DHCP” is selected and the unit is unable to retrieve an IP address, the unit will display a “self configured” IP address of 169.254.x.x. This is a perfectly valid IP address, but it may indicate an issue with the unit’s network connection. Double-check your Ethernet connection and verify that you are actually connected to the network.

To assign an IP address manually, de-select “Use DHCP” and enter the IP, Mask, Gateway, and DNS servers as appropriate. Click “Apply” to confirm the changes.

NOTE: You WILL need to reconnect to the unit once you make changes in this menu so double-check your settings for typos before applying them! Otherwise, you may find yourself locked out of a remotely (sometimes VERY remotely) located unit with a long, unplanned trip to the transmitter site ahead of you to fix it.

Outbound Connection

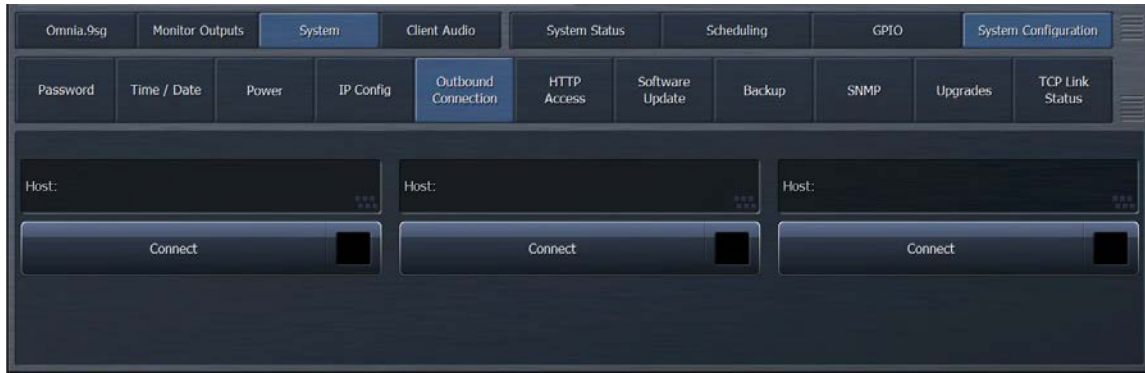

While the most common mechanism for connecting NfRemote to Omnia.9sg is via an IN-BOUND connection initiated from the remote client, in some cases (such as certain firewall restrictions) it may be more useful for the 9sg to initiate the connection to one or more remote clients.

This requires a bit more configuration since not only does the 9sg need to be set up to initiate the connection (s), NfRemote needs to be configured to accept them. 9sg will support up to 3 simultaneous outbound connections.

Configuring 9sg to Initiate an Outbound Connection

In the “Outbound Conn” menu, enter the IP address and port of the remote system running NfRemote. This could also be an external router IP address with port forwarding in some installations. Click “Connect”. 9sg will try repeatedly to connect to an instance of NfRemote at the specified IP address and port. If connection is not successful, attempts will gradually slow down until an “idle” rate of once every 4 minutes is reached. Once this state is reached, it may take as long as 5 minutes for a remote NfRemote client to receive an inbound connection request.

Configuring NfRemote to Accept an Inbound Connection

In NfRemote, select “Inbound Connection”. Specify a port on which NfRemote will be listening for connections from 9sg. While you do not have to specify an IP address, you may do so, or use wildcards such as 192.168.200.*:7000 to accept connections from any 9sg on the specified network at that port.

Typically, however, you would not want multiple units attempting to connect to the same NfRemote client on the same port.

The port **MUST** be specified and hostnames are **NOT** supported. Enter the password configured on the remote 9sg. Click “Add” to add this connection to the list, then click “Connect” to begin waiting for a connection. If all has been configured correctly, NfRemote should detect the connection attempt and display the remote interface for 9sg.

HTTP Access

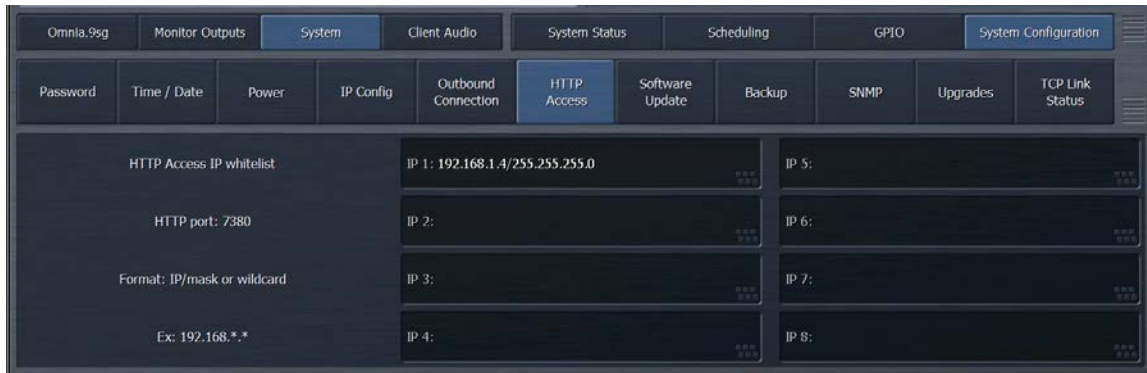

In addition to access via NfRemote, the 9sg has an extensive http remote control interface built in. It is not necessary to configure these settings if you do not plan to use the http interface. This menu **ONLY** controls access via the remote http interface and does **NOT** restrict access via NfRemote.

This interface allows access to nearly every single parameter available through NfRemote, and is useful for monitoring and control by automation or other external systems. The NfRemote client software can also be downloaded via this interface.

This interface can only be accessed by systems and networks specified in the “HTTP Access” menu. Up to 8 individual hosts or networks can be allowed access in the format of IP address, IP address and network mask, or IP address with wildcard (i.e. 192.168.200.20, 192.168.200.20/255.255.255.0, or 192.168.200.*). There is no username or password challenge on the http interface, so ensure that only the hosts and networks that need access are listed here

Software Update

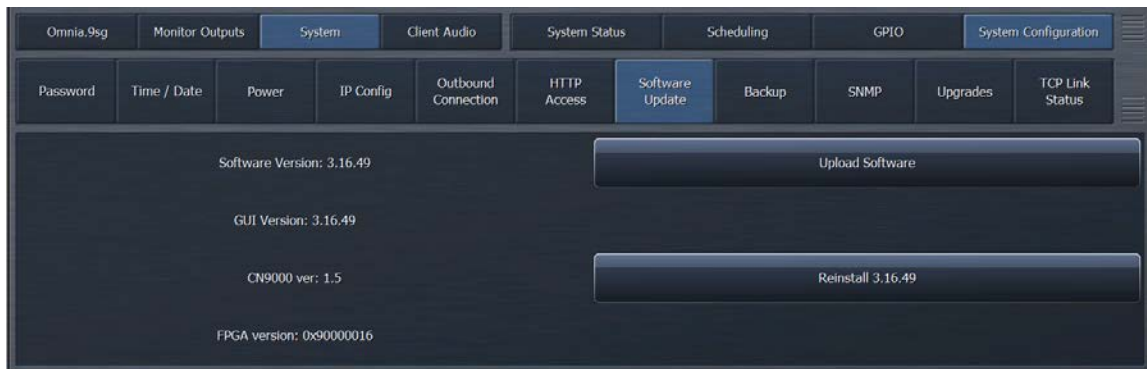

The “Software Update” menu displays the current 9sg software (and NfRemote client) version as well as the versions associated with several internal 9sg components.

Click “Upload Software” to upload a new version to 9sg, or click “Reinstall x.x.x” to reinstall the currently loaded software version on 9sg. This would normally only be done for troubleshooting purposes.

Backup

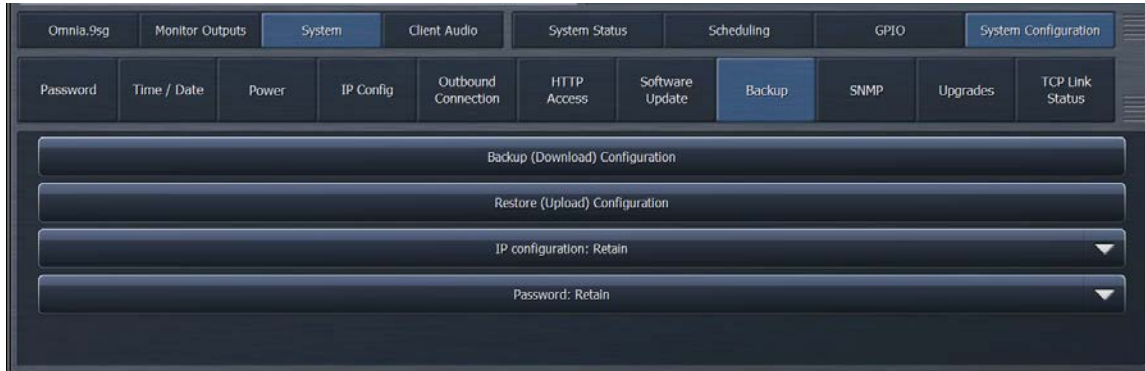

This menu allows a full backup and restore of the 9sg configuration. Although an update will normally not affect the unit’s configuration, it is a good idea to backup your configuration prior to performing a software update.

Click “Backup (Download) configuration” to retrieve a copy of the current configuration from the unit. Click “Restore (Upload) Configuration” to upload a previously downloaded configuration. The configuration files are stored in ZIP format and do not need to be unzipped prior to upload.

When restoring a configuration file, you have the option of either retaining the existing IP address and password, OR restoring these parameters from the uploaded configuration file.

Typically, both would be left at “Retain” to prevent losing access to the unit, though if you have a corporate password or IP addressing scheme stored with the configuration files, it may make sense to select “Override” instead.



SNMP

The SNMP menu provides the means to enter the information necessary to facilitate communication between Omnia.9sg and your SNMP manager. It supports SNMP V1 and V2c.

Disable SNMP in order to enter information. The “Communities” and “Trap Sink” fields accept community names and the IP addresses or names of the trap receiver. The e-mail address of the designated contact for alerts should be entered into the “Contact” field.

Information entered in the “Location” field appears on the front panel display and on remote connections and makes it possible to quickly identify which particular unit you are viewing, especially convenient if you are managing more than one site using Omnia.9sg.

The Omnia.9sg MIB file is available via the built-in HTTP server on the SNMP Test Page which can be accessed from any white-listed computer on the network. Enter the IP address of Omnia.9sg followed by the port number and “/SNMP” as follows, substituting your IP address: <http://192.168.1.1:7380/SNMP>”.

A test mode has also been included to help with setup and verify proper SNMP configuration and communications.

Please note that when in test mode, no auto-generated SNMP traps will be sent and any GETs will return the test value, not the actual value.

Remember to enable SNMP when configuration is complete.

Upgrades

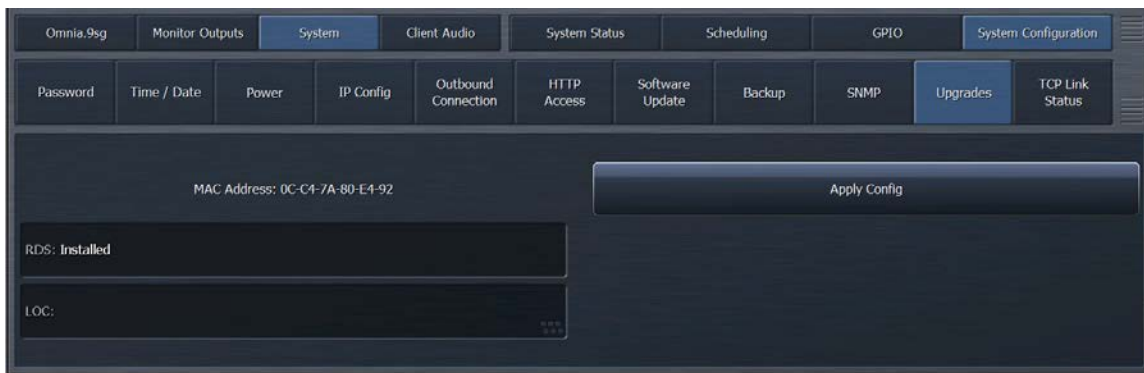

If you have upgraded 9sg with RDS after purchase (or any other future options that may be released), the license key that you receive would be applied here. The MAC address is also provided in this menu. The factory will need the unit’s MAC address in order to generate a license key for any upgrades.

6 Client Audio

Arguably one of the most powerful features of 9sg is the ability to stream lossless audio (bandwidth permitting) from various patch points within 9sg directly through the NfRemote client. While it may not always be practical to establish a calibrated “reference” monitoring position directly at the location where 9sg is installed, this feature allows you to perform very accurate and detailed audio monitoring remotely. This would even include sources connected to the unit’s external MPX inputs such as a remotely located tuner or backup audio processor.

The “Client Audio” menu is divided into four submenus, each with their own set of parameters... “Client Audio Out”, “Client Mic Input”, “Client File Recorder”, and “Client IP Options”.

Client Audio Out

This menu allows control of audio output from the NfRemote client, including the patch point, and various monitoring calibration controls. The additional submenus in this section are identical to those in the “Monitor Outputs” section.

“Patch Point” Menu

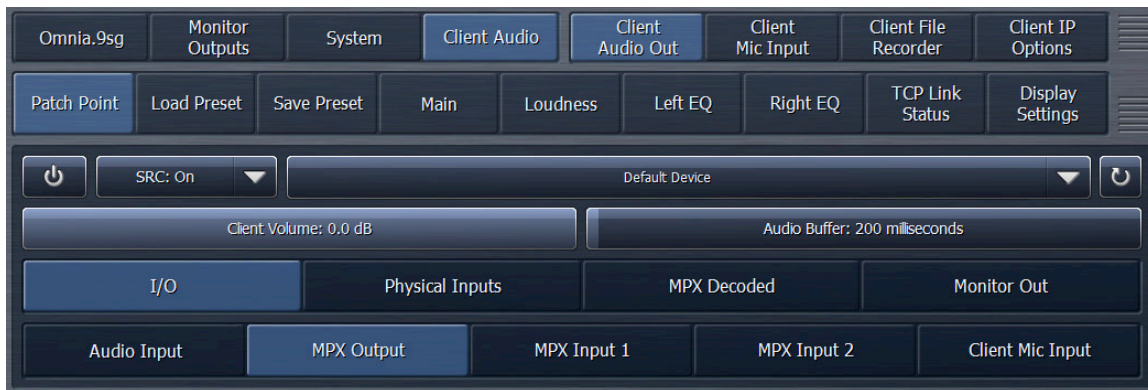

To enable client audio output, click the “power button” icon in this menu. A selectable Sample Rate Converter (SRC) ensures that the audio remains stable, though when enabled this feature consumes additional CPU resources.

All available audio devices on the system for client audio output will be enumerated in the dropdown list next to the SRC control. Click the “reload” icon to update this list.

Client volume and buffer length are both adjustable as well. If you are experiencing audio dropouts, increase the “Audio Buffer” setting. This buffer can hold up to 10 seconds of audio to accommodate even the most hostile network conditions.

The patch points available for selection in this menu are identical to those described earlier in the “Monitor Outputs” section of the manual. The only exceptions are the addition of the “Client Mic Input” and the addition of the monitor outputs themselves. The “Monitor Out” menu has patch points for the headphone, speaker, and aux monitoring paths. Each monitoring path provides three selections to feed client audio...input source, pre-calibration (xo), and post-calibration (output).

Controls are also provided for loading and saving client audio output monitor calibration settings.

Client Mic Input

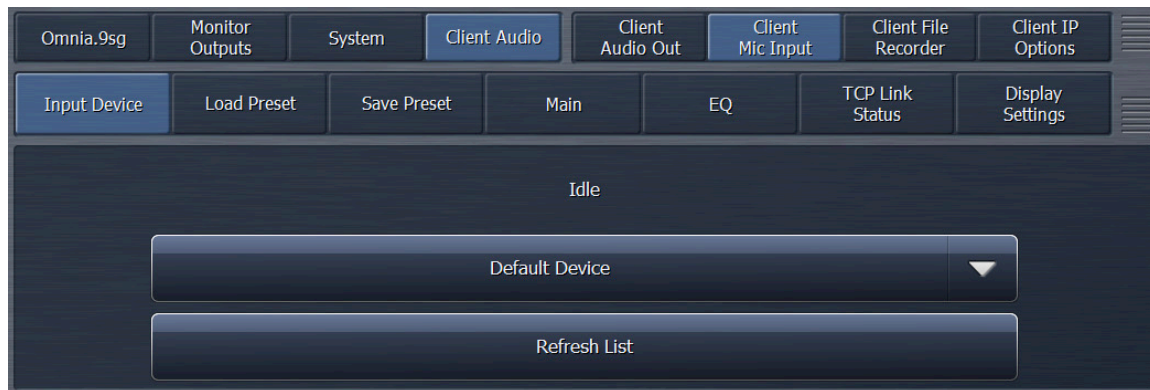

The Client Microphone Input Menu allows you to pick which microphone you’d like to use, a parametric equalizer to create custom EQ curves for individual mics, and the ability to save and recall custom mic presets.

Input Device

Allows selection of the device or input that will feed the NfRemote client when performing monitor calibration. Click “Refresh List” to update the list of devices.

Load/Save Preset

These menus allow you to save custom calibration profiles for measurement microphones and function identically to the Load/Save menus described elsewhere in this manual.

Main

These controls bypass the microphone calibration EQ and adjust gain when bypassed or engaged.

EQ

A 12-band parametric EQ is provided for the client microphone input. This can be used to compensate for the response curve of the measurement microphone and functions identically to the EQ section described in the “Monitor Outputs” menu.

Client File Recorder



In addition to the streaming client audio, NfRemote also features a “Client File Recorder” function which allows recording audio from up to three different patch points within the unit simultaneously. The recordings will be stored on the machine running NfRemote at the specified folder path with the specified filename (s). Depending on network bandwidth, these recordings will either be a lossless PCM (Nicam) or Vorbis source and stored as lossless FLAC files. Files can be split with various durations, and recording can be triggered by presence of audio (VOX).

Client IP Options

This menu provides information about the host running NfRemote, and allows establishing an “Outbound Connection” (described earlier) from one instance of NfRemote to another specifically for client audio.

7

Frequently Asked Questions

What is this thing and what exactly does it do again?

The 9sg is a great companion to any other existing audio processor where you need to “split” the main audio processing from the final limiter/clipper and stereo generator section. This would include cases where you want to use a single audio processor at the studios to feed multiple remote sites, while still maintaining the highest quality audio possible with minimum loss of loudness. In short, it’s the same excellent stereo generator that we included in Omnia.9 (and a bunch of the other cool tools) with a final clipper section that improves upon the already excellent one in Omnia.9. We didn’t even think that was possible.

Beyond this flexibility and stellar audio performance, Omnia.9sg also provides internal playback capability with built-in processing should you lose your primary or secondary audio feed (s). Optionally, it can also accept and process locally inserted audio to provide location-specific content.

I don’t have an Omnia.9—Can 9sg still benefit me?

ABSOLUTELY! ANY audio processor could potentially benefit from the improved final clipper included with 9sg. With Omnia.9 you would feed the “Pre-Final” patch point (pre-final limiter/clipper) into 9sg. This patchpoint is the ideal location for feeding the pre-emphasis and clipper in 9sg. With other audio processors you could still use an “HD” or “Digital” output (adjusted for little or no final limiting) and achieve a good end result. You could also use other outputs such as an FM output with no pre-emphasis (again, adjusted for minimum limiting/clipping) though the 15 kHz low-pass filtering typically present on such an output would result in less than ideal results since 9sg actually does its low-pass filtering at 16.5 kHz by default, resulting in better high-frequency response.

What about RDS?

Yup. 9sg has an integrated RDS generator which can be enabled in the field via an optional license key if not purchased with the unit. This RDS generator supports UECP and dynamic RDS, as well as full control and updates from external automation systems via the 9sg http interface.

What else have I won, Bob?

Congratulations! Your new 9sg also includes full remote control and MPX analysis via NfRemote from anywhere you have an Internet connection! Monitor your entire MPX signal (or your competitor's with an external tuner) via the integrated test instrumentation (FFT, modulation analysis, loudness metering, oscilloscope, RTA). Not only can you LOOK at signals, you can also HEAR them via remote Client Audio!

So I've read through this entire manual and I STILL have questions. Now what?

We realize reading manuals isn't exactly thrilling—and hopefully this one covered most of the high points—but if you want to talk to one of our helpful support techs about your new 9sg, feel free to e-mail support@telosalliance.com or call +1-216-241-7225.

8 Specifications

Frequency Response

+/-0.5dB 20Hz to 16.5 kHz

Signal to Noise Ratio

Greater than -80dBu de-emphasized, 20Hz to 15kHz

Stereo Separation

65dB minimum, 20Hz to 15kHz, 70dB typical

Digital Output Level

Adjustable from -24.0dBFS to 0.0dBFS in 0.1dB increments

Stereo Baseband Output

Adjustable from -2dBu to +22dBu (0.1dB increments) into 600-Ohms, 20-Ohm output impedance

Analog I/O

Two balanced, EMI filtered XLR connectors

Composite I/O

Four 75-Ohm BNC female, two inputs, two outputs

Digital I/O

AES/EBU via XLR connector and external sync via BNC

Remote Control

RJ45 supporting 1000 BASE-T Ethernet connections

Power Requirements

100-264 VAC, 47-63Hz autosensing, dual PSU

Power Connector

Dual IEC male, detachable 3-wire power cords supplied

Power Supply

Internal dual redundant

Environmental

Operating: 0 to 50 degrees C

Non-operating: -20 to 70 degrees C.

Regulatory

North America: FCC and CE tested and compliant, power supply is UL approved.

Europe: Complies with the European Union Directive 2002/95/EC on the restriction of the use of certain hazardous substances in electrical and electronic equipment (RoHS), as amended by Commission Decisions 2005/618/EC, 2005/717/EC, 2005/747/EC (RoHS Directive), and WEEE.

9

Telos Alliance Warranty

Telos Alliance Limited Warranty



Telos Alliance Radio Division has an industry-leading five-year warranty. As a company, we are committed to our products and the pursuit of providing better quality to our customers.

Find the Warranty online at www.telosalliance.com/warranty.

This page intentionally left blank

This page intentionally left blank

This page intentionally left blank

