

ART 932-A

PROFESSIONELLE AKTIVBOX

BESCHREIBUNG

Die ART 932-A bietet innovative Technologien und überirdischen Sound für anspruchsvolle Audio-Anwendungen. Die Kombination aus einem 3-Zoll-Titan/Neodym-Kompressionstreiber, einem 12-Zoll-Tieftöner, einer 2-Kanal-Endstufe mit 2100 W und einem Constant Directivity True Resistive Waveguide sorgt für eine konsistente 100° x 60° Abdeckung des Hörbereichs mit bis zu 132 dB SPL verzerrungsfreiem Klang.

Dank der RCF-exklusiven FIRPHASE und Bass Motion Control Algorithmen, die genau auf die einzelnen Modelle abgestimmt sind, erlebt Ihr Publikum eine absolut transparente Klangwiedergabe und einen umfangreichen, druckvollen Bassbereich.

Das elegante Polypropylen-Gehäuse ist zur Stabilisierung mit einem internen M-Rahmen ausgestattet. Dadurch ist es leicht transportierbar und kann mithilfe mehrerer Befestigungspunkte sicher auf einem Stativ, fliegend, an der Wand oder einer Traverse montiert werden.



FUNKTIONEN

- Bis zu 132 dB Schalldruckpegel
- 2-Kanal-Class-D-Endstufe, 2100 W
- Linearer Übertragungsbereich 45 - 20000 Hz
- 3-Zoll-Titan-/Neodym-Kompressionstreiber
- 12-Zoll-Tieftöner
- FIRPHASE 0 Grad Phasengang
- Bass Motion Control Intelligente Steuerung der Tieftöner-Auslenkung

SPEZIFIKATIONEN

Spezifikation	Frequenzgang:	50 Hz ÷ 20000 Hz
	Max SPL @ 1m:	132 dB
	Horizontaler Abstrahlwinkel:	100°
	Vertikaler Abstrahlwinkel:	60°
Schallwandler	Kompressionstreiber:	1 x 1.4" neo, 3.0" v.c
	Woofers:	12", 2.5" v.c
Input/Output sektion	Eingangssignal:	bal/unbal
	Eingangsbuchsen:	XLR, Jack
	Ausgangsanschlüsse:	XLR
	Eingangsempfindlichkeit:	-2 dBu/+4 dBu
Prozessor	Übergangsfrequenz:	700Hz
	Schutzschaltungen:	Thermal, RMS
	Limiters:	Soft Limiter
	Steuerung:	Linear, Boost, Stage, Volume
Power sektion	Gesamtleistung:	2100 W Peak
	HF Bereich:	700 W Peak
	Tiefe Frequenzen:	1400 W Peak
	Kühlung:	Convection
	Verbindungen:	VDE
Standardkonformität	Safety agency:	CE compliant
Physikalische daten	Gehäuse Material:	PP Composite
	Hardware:	1 x M10 Top, 1 x M10 each side
	Griffe:	1 Top , 1 each side
	Pole Mount/Cap:	Yes
	Gitter:	Steel
	Farbe:	Black
Größe	Höhe:	642 mm / 25.28 inches
	Breite:	370 mm / 14.57 inches
	Tiefe:	363 mm / 14.29 inches
	Gewicht:	18.8 kg / 41.45 lbs
Versandinformationen	Verpackung Höhe:	685 mm / 26.97 inches
	Verpackung Breite:	430 mm / 16.93 inches
	Verpackung Tiefe:	423 mm / 16.65 inches
	Verpackungsgewicht:	21 kg / 46.3 lbs



ARTIKEL-NUMMER

- **13000681**
ART 932-A
115V
EAN 8024530019266

- **13000680**
ART 932-A
220-240V
EAN 8024530019112

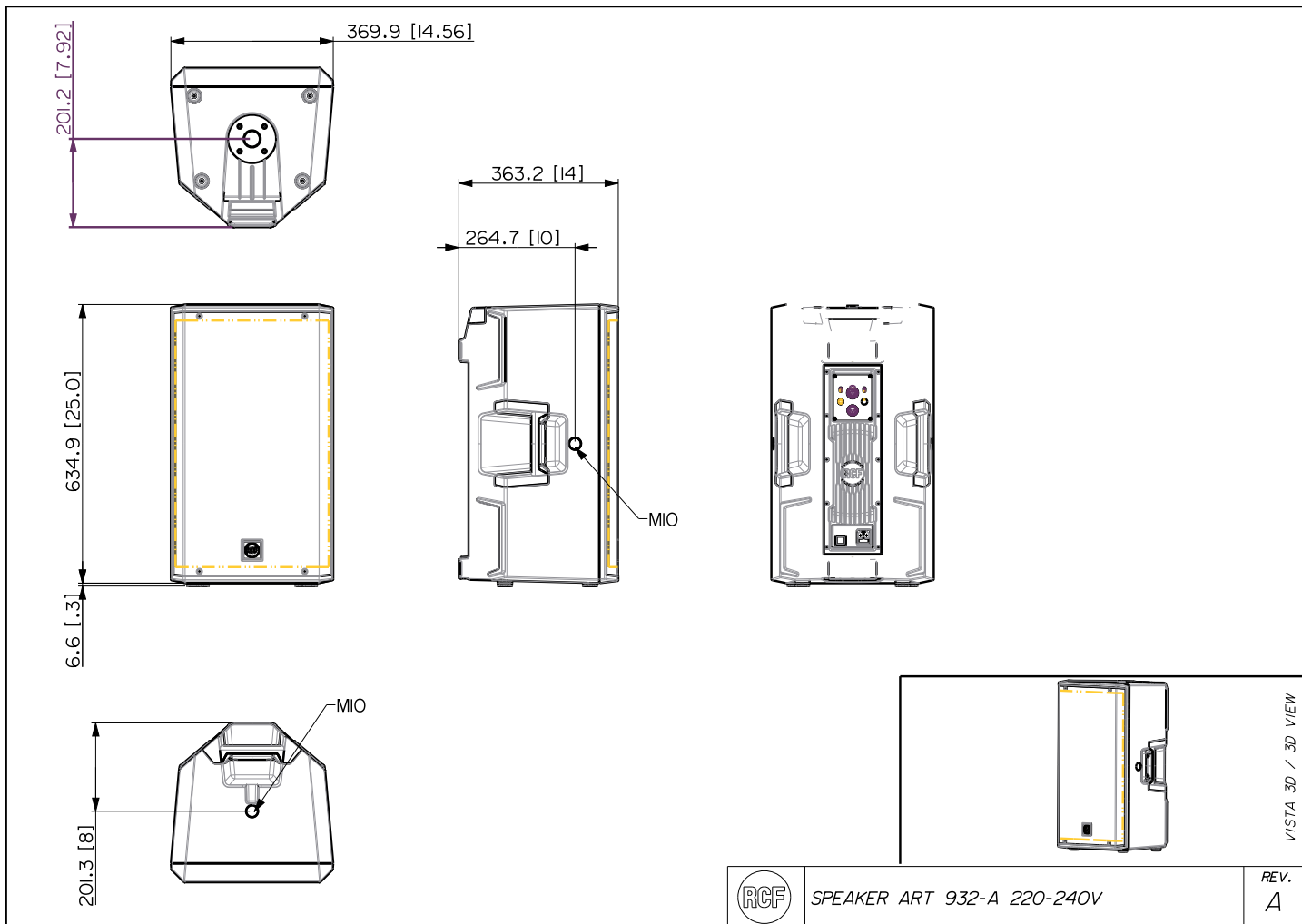

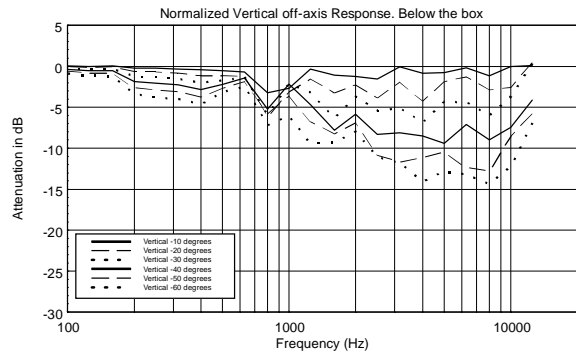
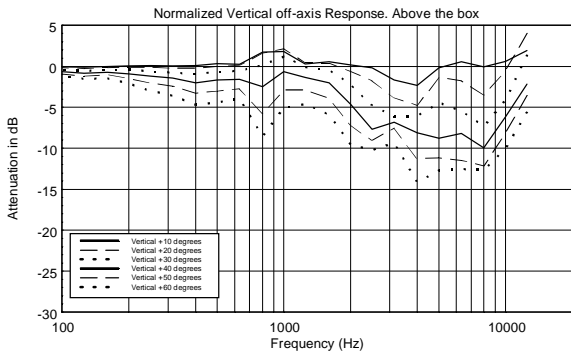
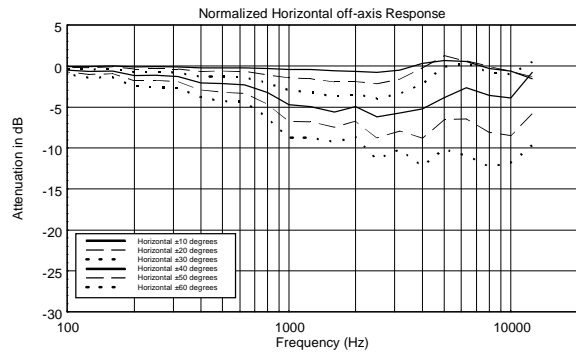
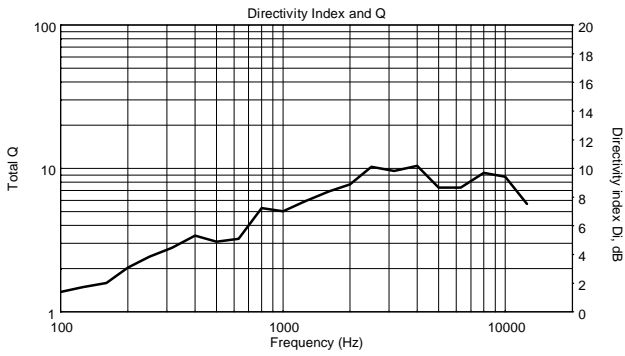
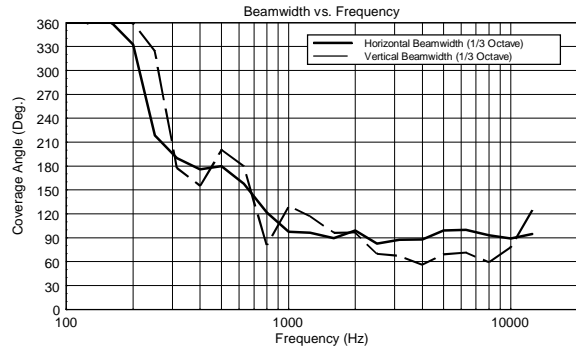
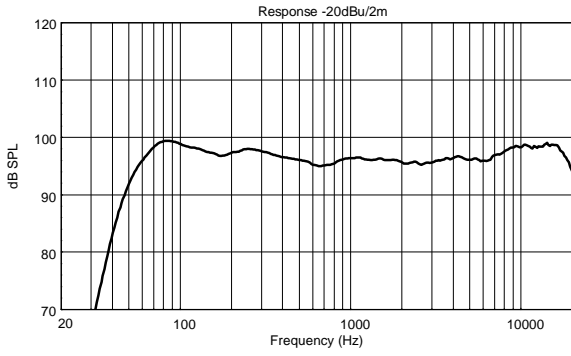

Horizontal 1/3 Octave Polars

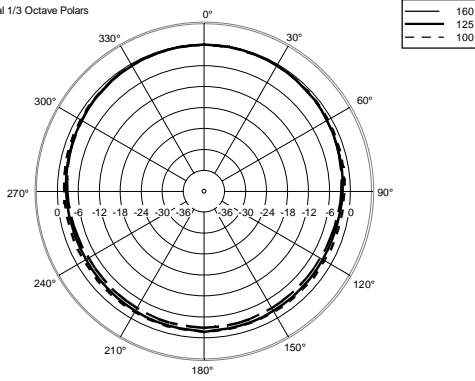

Horizontal 1/3 Octave Polars

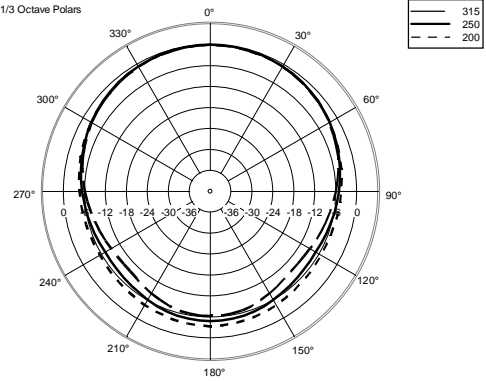

Horizontal 1/3 Octave Polars

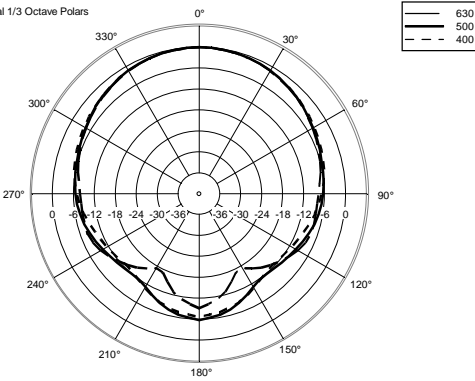

Horizontal 1/3 Octave Polars

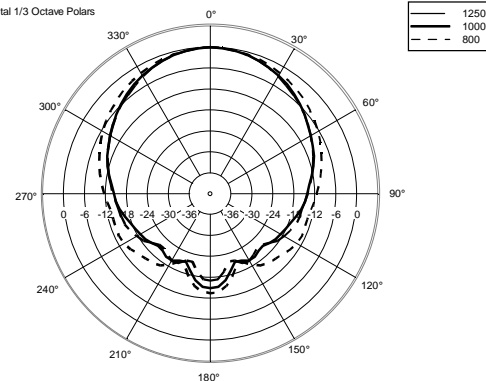

Horizontal 1/3 Octave Polars

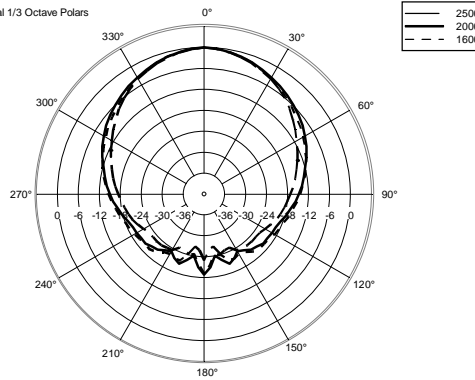

Horizontal 1/3 Octave Polars

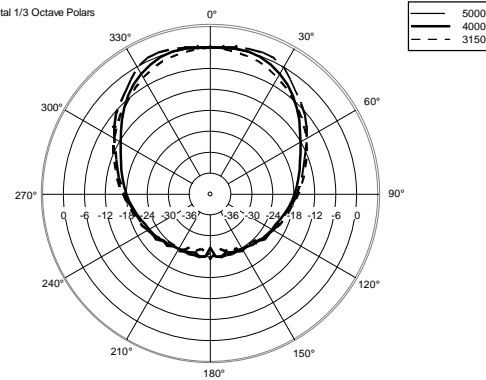

Horizontal 1/3 Octave Polars

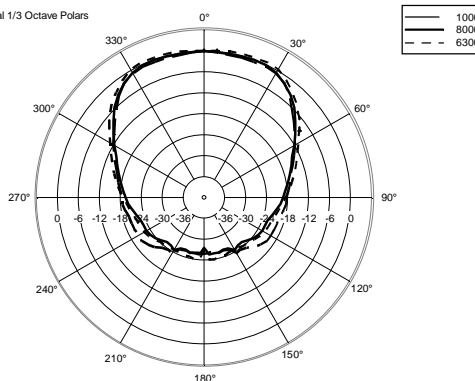



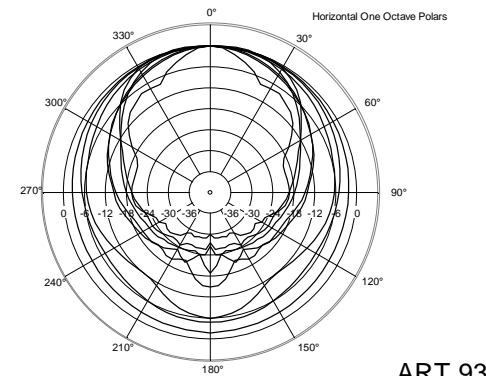

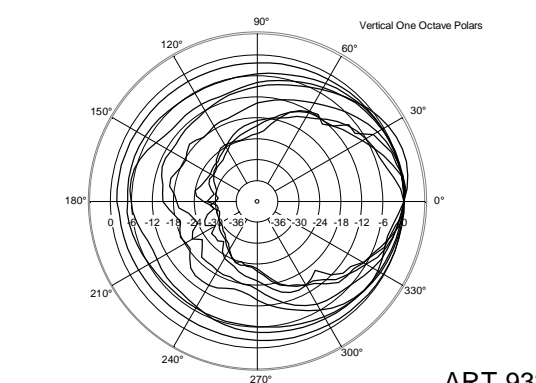
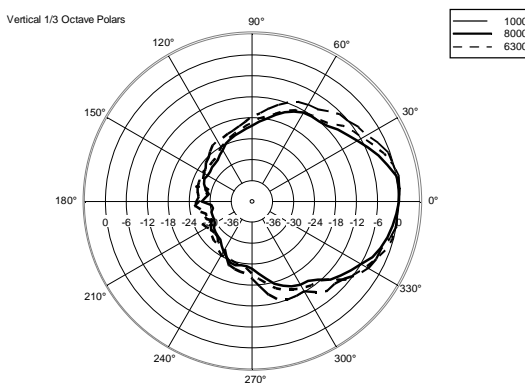
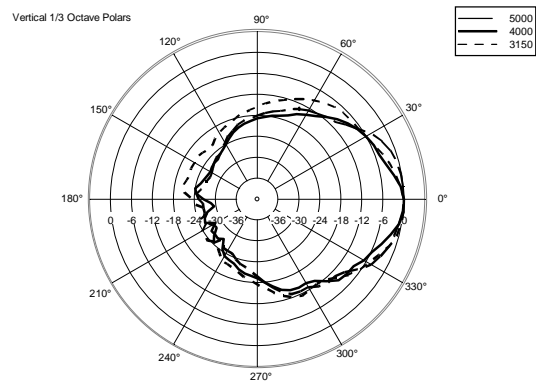
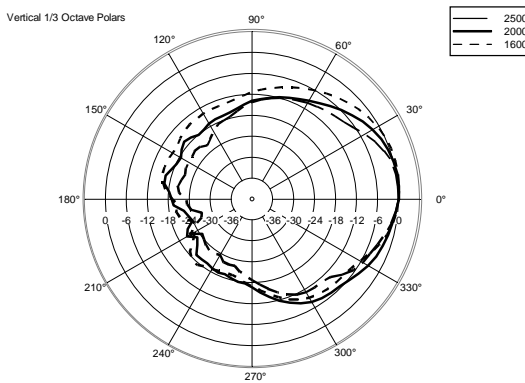
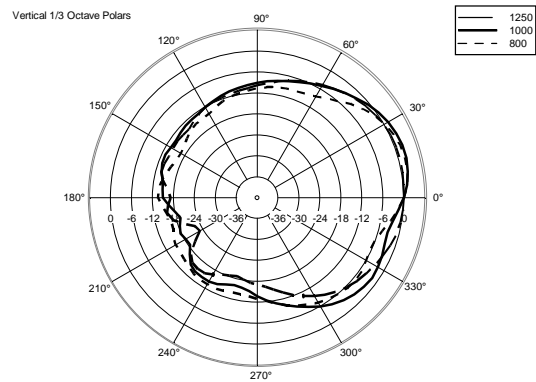
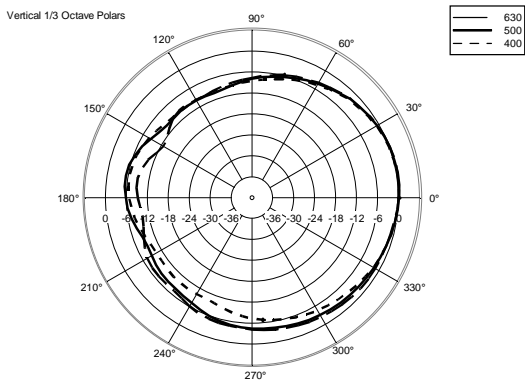
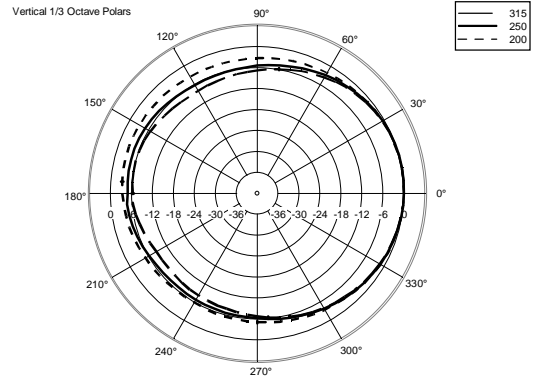
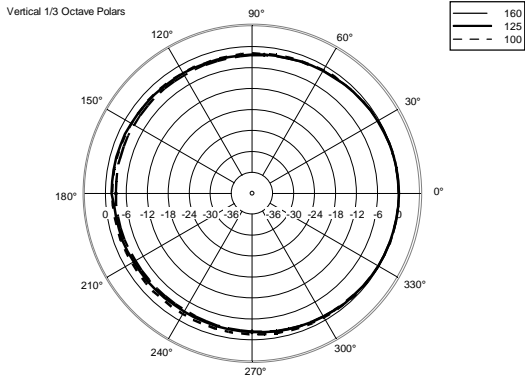



Horizontal One Octave Polars





ZUBEHÖR

	AC PM-M20	ARTIKEL- NUMMER EAN:	13360067 8024530014599
	AC PMX POLE MOUNT M20	ARTIKEL- NUMMER EAN:	13360232 8024530010058
	AC PRO-FS PROFESS. LOCKING FLOOR STAND	ARTIKEL- NUMMER EAN:	13360109 8024530006471
	AC PRO-PM PROFESS. LOCKING POLE MOUNT	ARTIKEL- NUMMER EAN:	13360110 8024530006488
	COVER CVR ART 912	ARTIKEL- NUMMER EAN:	13360474 8024530018849
	FLYING BRACKET FL-BR ART 912	ARTIKEL- NUMMER EAN:	13360477 8024530019204
	HORIZONTAL BRACKET H-BR ART 912	ARTIKEL- NUMMER EAN:	13360475 8024530019228
	VERTICAL BRACKET V-BR ART 912	ARTIKEL- NUMMER EAN:	13360476 8024530019211