

TTP 4-A

AKTIVER 2-WEGE-ARRAYLAUTSPRECHER MIT SCHMALER ABSTRAHLUNG

BESCHREIBUNG

Als Punktschallquelle bietet die TTP 4-A erstklassigen Klang für anspruchsvolle, kleine bis mittelgroße Veranstaltungen im Innen- oder Außenbereich. Der ausgewogene Frequenzgang und die optimale Sprachverständlichkeit werden jeden Tontechniker überzeugen, das Design ist schlicht und flexibel. Die Box ist optimal geeignet für Groundstacking oder geflogene Anwendungen, bei denen eine präzise Abstrahlung erwünscht ist. Mit allen Vorzüge der TT+ Technologie ausgestattet, wie eine gleichmäßige Abdeckung, hohe Leistung und herausragende Präzision, ist sie ideal für professionelle Anwendungen.



FUNKTIONEN

- 135 dB maximaler Schalldruckpegel
- 2 x Class-D-Endstufen, 1600 Watt RMS Gesamtleistung
- 2 x 10-Zoll-Neodym-Tieftöner, 3,0-Zoll Schwingspule
- 1,5-Zoll-Neodym-Hochton-Kompressionstreiber, 4-Zoll-Schwingspule
- Abdeckung 60° x 25°
- Frequenzgang 45 - 20.000 Hz
- Integriertes RDNet
- FiRPHASE mit 0 Grad Phase

SPEZIFIKATIONEN

Spezifikation	Frequenzgang:	45 Hz ÷ 20000 Hz
	Max SPL @ 1m:	135 dB
	Horizontaler Abstrahlwinkel:	60°
	Vertikaler Abstrahlwinkel:	25°
Schallwandler	Kompressionstreiber:	1 x 1.5" neo, 4.0" v.c
	Woofer:	2 x 10" neo, 3.0" v.c
Input/Output sektion	Eingangssignal:	bal/unbal
	Eingangsbuchsen:	XLR, RDNet Ethercon
	Ausgangsanschlüsse:	XLR, RDNet Ethercon
	Eingangsempfindlichkeit:	+4 dBu
Prozessor	Übergangsfrequenz:	900Hz
	Schutzschaltungen:	Thermal, RMS
	Limiter:	Fast Limiter
	Steuerung:	Selectable preset, volume, delay
	RDNet:	Yes
Power sektion	Gesamtleistung:	3200 W Peak, 1600 W RMS
	HF Bereich:	1200 W Peak, 600 W RMS
	Tiefe Frequenzen:	2000 W Peak, 1000 W RMS
	Kühlung:	Convection
	Verbindungen:	Powercon IN/OUT
Physikalische daten	Gehäuse Material:	Baltic birch plywood
	Hardware:	Array fittings, 2xM10 on the top, 2xM8 on each side
	Griffe:	2 Side, 2 Rear
	Pole Mount/Cap:	Yes
	Gitter:	Steel
	Farbe:	Black
Größe	Höhe:	825 mm / 32.48 inches
	Breite:	316 mm / 12.44 inches
	Tiefe:	369 mm / 14.53 inches
	Gewicht:	30.4 kg / 67.02 lbs
Versandinformationen	Verpackung Höhe:	410 mm / 16.14 inches
	Verpackung Breite:	865 mm / 34.06 inches
	Verpackung Tiefe:	365 mm / 14.37 inches
	Verpackungsgewicht:	33.5 kg / 73.85 lbs



ARTIKEL-NUMMER

- **13000604**

TTP 4-A

EAN 8024530017767

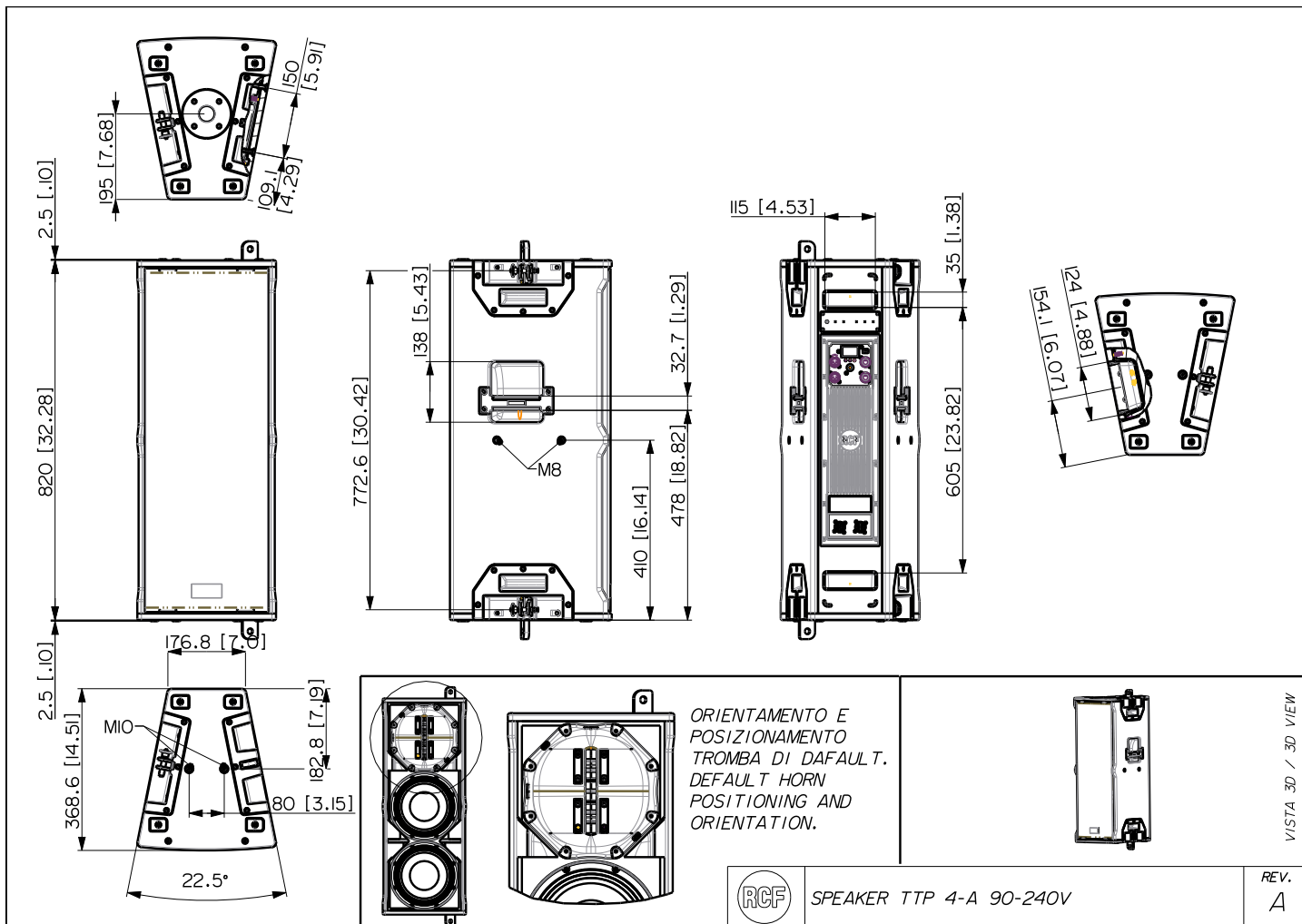

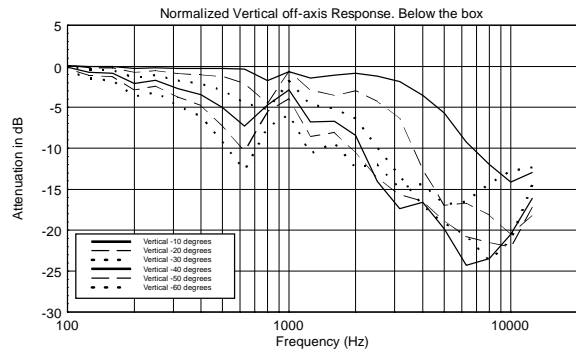
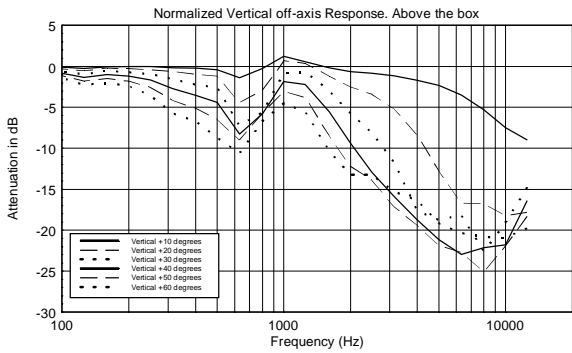
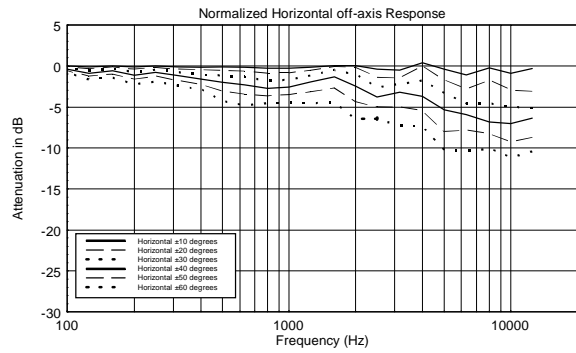
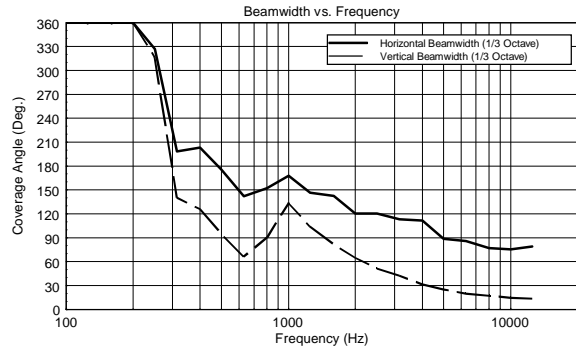
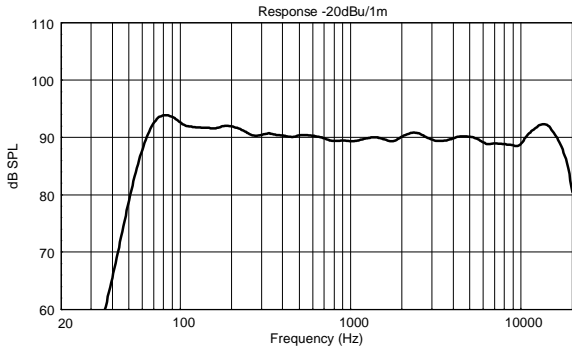

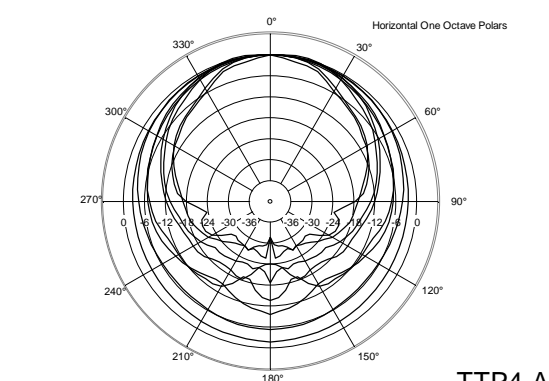
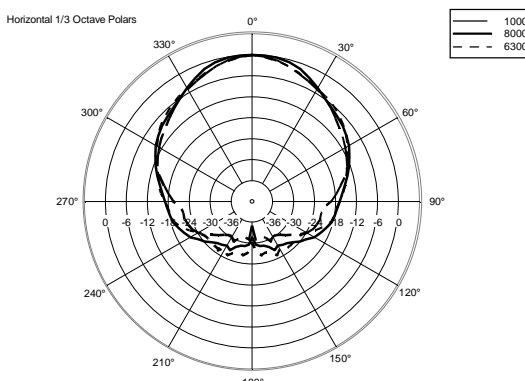
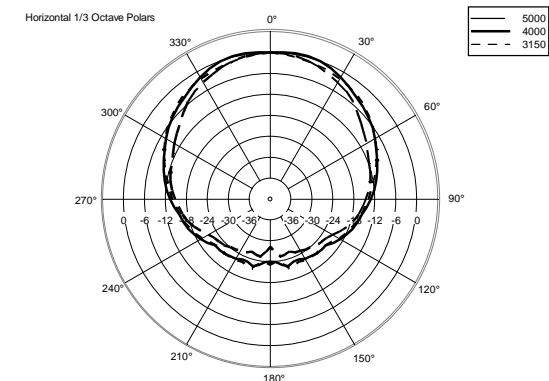
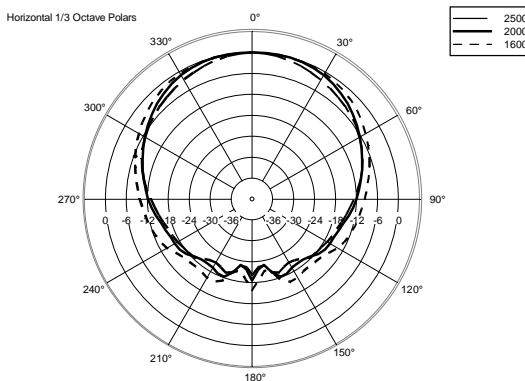
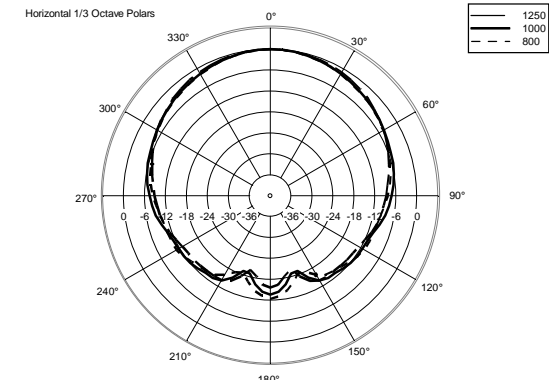
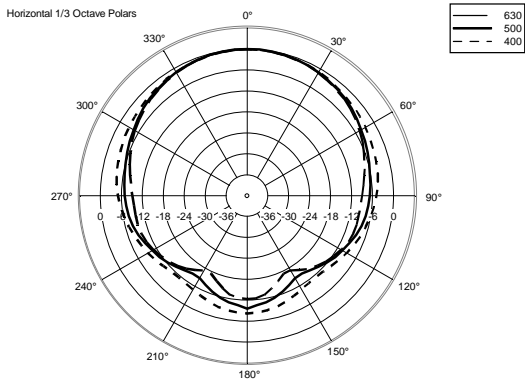
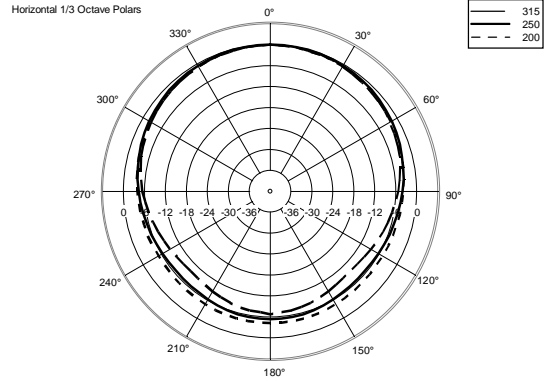
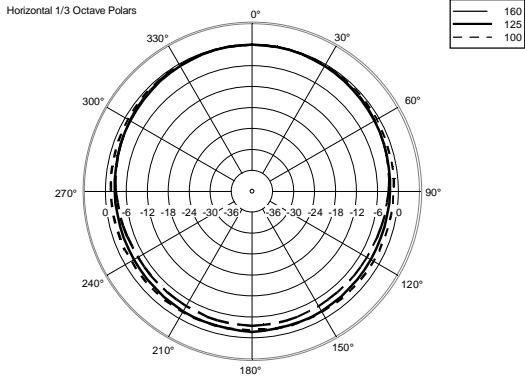

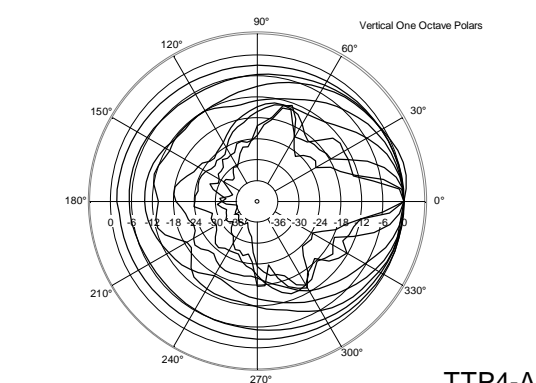
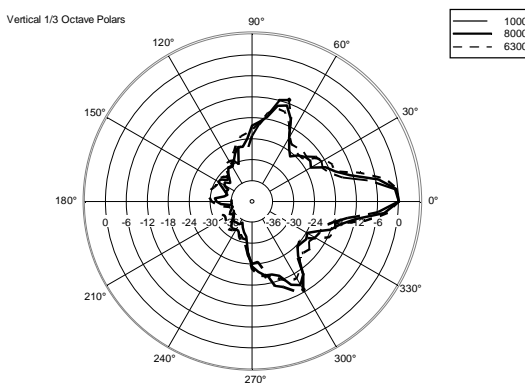
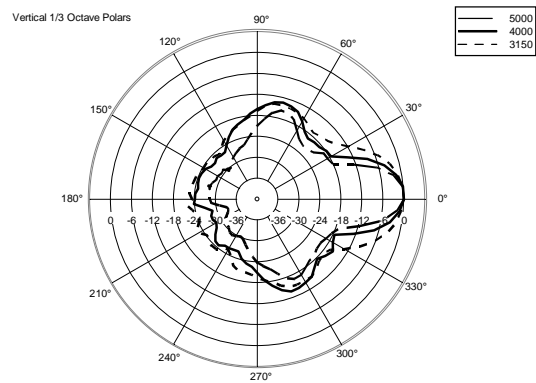
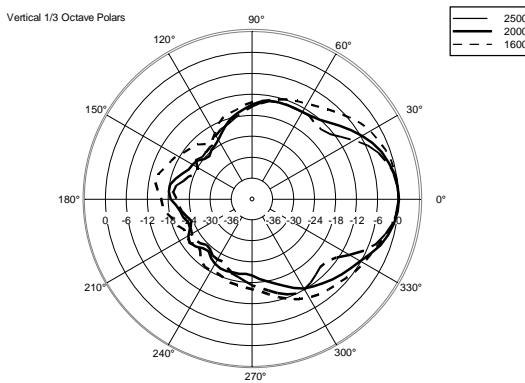
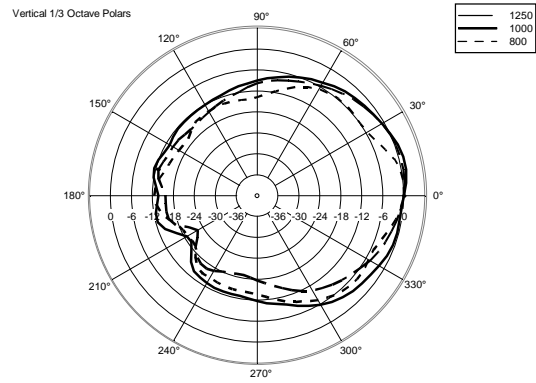
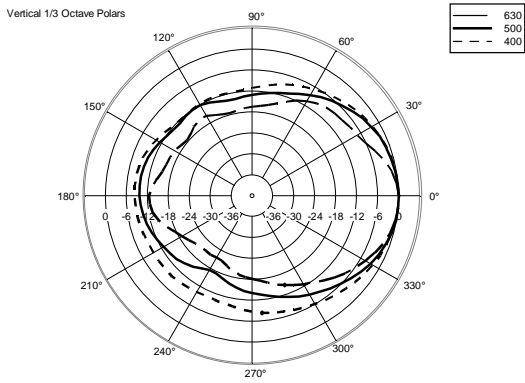
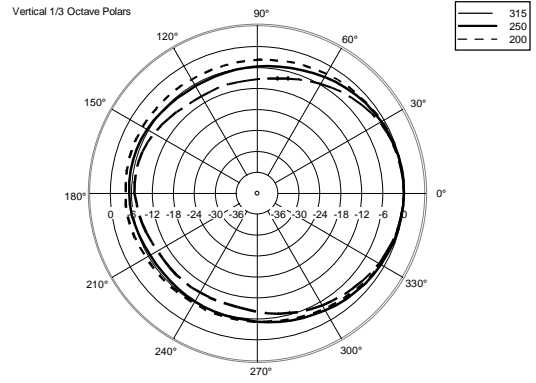
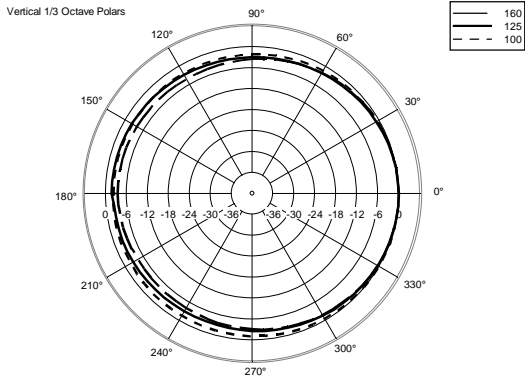

















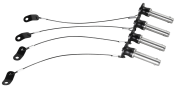

ZUBEHÖR

	AC PMX POLE MOUNT M20	ARTIKEL- NUMMER EAN:	13360232 8024530010058
	AC PRO-FS PROFESS. LOCKING FLOOR STAND	ARTIKEL- NUMMER EAN:	13360109 8024530006471
	AC PRO-PM PROFESS. LOCKING POLE MOUNT	ARTIKEL- NUMMER EAN:	13360110 8024530006488
	CABLES KIT CBL ETHERCON 0.7M	ARTIKEL- NUMMER EAN:	12399016 8024530013844
	CABLES KIT CBL ETHERCON 1.5M	ARTIKEL- NUMMER EAN:	12399017 8024530013851
	CABLES KIT CBL ETHERCON 3M	ARTIKEL- NUMMER EAN:	12399035 8024530013868
	CABLES KIT CBL ETHERCON 5M	ARTIKEL- NUMMER EAN:	12399018 8024530013875
	CABLES KIT CBL ETHERCON TO XLR F 0.2M	ARTIKEL- NUMMER EAN:	12399019 8024530013882
	CABLES KIT CBL ETHERCON TO XLR M 0.2M	ARTIKEL- NUMMER EAN:	12399020 8024530013899

	CABLES KIT CBL POWERCON LINK 0.7M	ARTIKEL-NUMMER EAN:	12399031 8024530013738
	CABLES KIT CBL POWERCON LINK 1.5M	ARTIKEL-NUMMER EAN:	12399030 8024530013721
	COVER CVR TT 4	ARTIKEL-NUMMER EAN:	13360440 8024530017583
	FLY BAR FL-B H TT 4	ARTIKEL-NUMMER EAN:	13360425 8024530018498
	FLY BAR FL-B V TT 4	ARTIKEL-NUMMER EAN:	13360423 8024530017668
	FLY BAR PICKUP FL-B PK HDL 6	ARTIKEL-NUMMER EAN:	13360372 8024530014353
	LINK BAR FL-B LINK TT 4	ARTIKEL-NUMMER EAN:	13360428 8024530017620
	QUICK LOCK PIN QL-PIN D11.2 L31 4X	ARTIKEL-NUMMER EAN:	13360335 8024530013257
	RAIN PROTECTION RP 1X HDL 30	ARTIKEL-NUMMER EAN:	13360388 8024530015138
	VERTICAL BRACKET V-BR TT 4	ARTIKEL-NUMMER EAN:	13360427 8024530017637

