

HL 2260

HORN LOADED TWO-WAY ARRAY 60° X 22.5°

DESCRIPTION

HL 2260 is a horn loaded two-way bi-amped array system that incorporates 2 x 12" woofer and a titanium dome 4.0" voice coil titanium compression driver for mid distance and long throw applications. The system is very compact and provides very high output and accurate voice and sound reproduction. The system is equipped with the latest generation of RCF precision transducers. The system has a 60° x 22.5° constant directivity and is ideally used in point source configuration for mid distance applications or can be clustered with narrower angles for long throw applications. The loudspeaker enclosure shape is trapezoidal and offers a 22.5° coupling angle each side. Connections to the amplifier are made through a watertight Amphenol multi-pole connector. The grille is in custom perforated steel, epoxy coated, with open-cell fibres and water repellent woven fabric backing. The cabinet is constructed of Baltic birch marine plywood and finished in a very resistant, textured, polyurea black paint. HL 2260 is weatherproof with protection code IP 55.



FEATURES

- 1500 W system power handling (RMS)
- 141 dB max SPL
- 60° x 22.5° constant directivity, horn-loaded
- IP 55 protection code
- 60 Hz ÷ 20000 Hz frequency range
- 2 x 12" high power woofers (3.5" v.c.)
- 1 x 4.0" v.c. compression driver, titanium dome
- Baltic Birch Plywood enclosure with internal structural metal bracings
- Safe and solid variable array mechanics
- Amphenol IP 67 in/out connectors

TECHNICAL SPECIFICATIONS

Acoustical specifications	Frequency Response (-10dB):	60 Hz ÷ 20000 Hz
	Frequency Response (-3dB):	80 Hz ÷ 20000 Hz
	Max SPL @ 1m:	141 dB
	Horizontal coverage angle:	60°
	Vertical coverage angle:	22.5°
	Directivity index Q:	14
Power section	Amplification:	Bi-Amp
	Crossover Frequencies:	600 Hz
	Nominal Impedance LF:	8 ohm
	Power Handling LF:	1350 W
	Peak Power Handling LF:	5400 W
	Recommended Amplifier LF:	2700 W
	Sensitivity LF:	104 dB
	Nominal Impedance HF:	8 ohm
	Power Handling HF:	150 W
	Peak Power Handling HF:	600 W
	Recommended Amplifier HF:	300 W
	Sensitivity HF:	113 dB
Transducers	Compression Driver:	1 x 2.0" neo, 4.0" v.c
	Woofer:	2 x 12", 3.5" v.c
Input/Output section	Input connectors:	Amphenol eco/mat IP 67
	Output connectors:	Amphenol eco/mat IP 67
Standard compliance	IP protection grade:	IP 55
	Safety agency:	CE compliant
Physical specifications	Cabinet/Case Material:	Baltic birch plywood
	Hardware:	Side and rear array rigging point
	Grille:	Steel
	Color:	Black
Size	Height:	530 mm / 20.87 inches
	Width:	771 mm / 30.35 inches
	Depth:	635 mm / 25 inches
	Weight:	66 kg / 145.5 lbs
Shipping information	Package Height:	799 mm / 31.46 inches
	Package Width:	859 mm / 33.82 inches
	Package Depth:	619 mm / 24.37 inches
	Package Weight:	70.4 kg / 155.21 lbs



PART NUMBER

- **13000407**

HL 2260

EAN 8024530011611

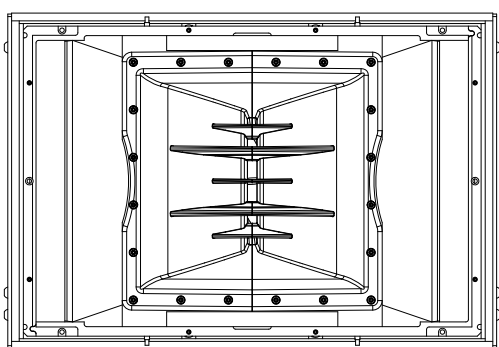
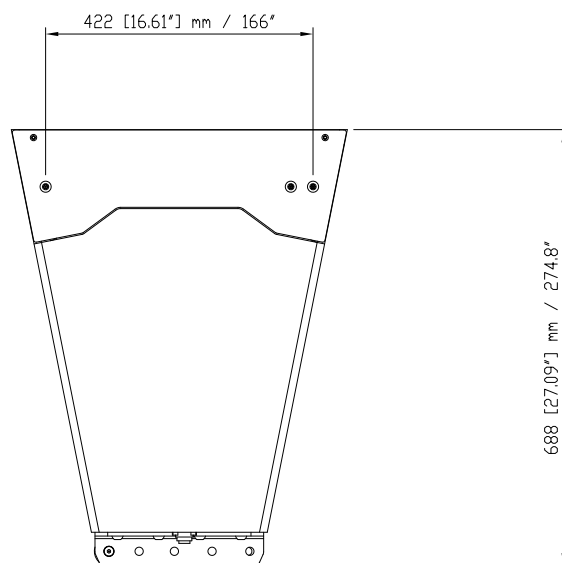
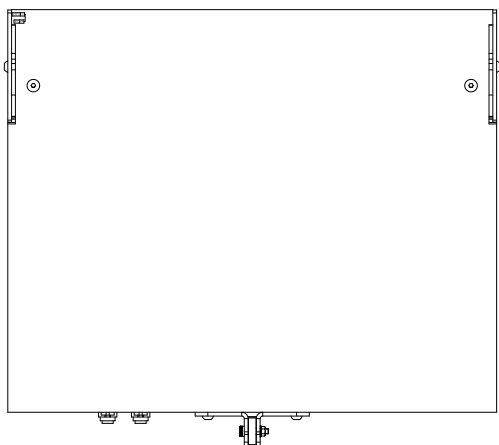
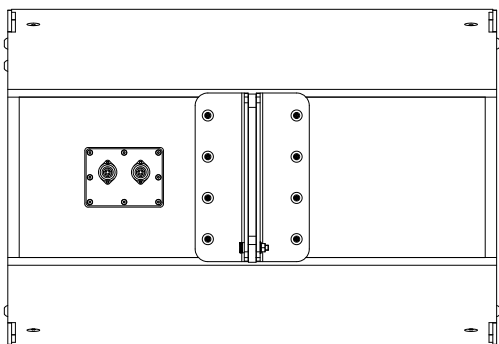

HL 2260
66 KG

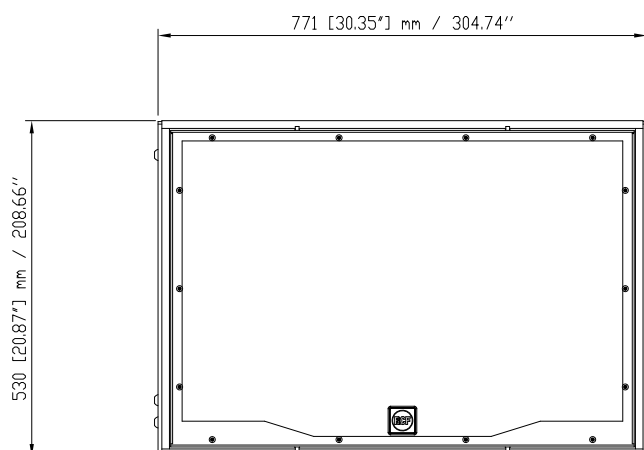

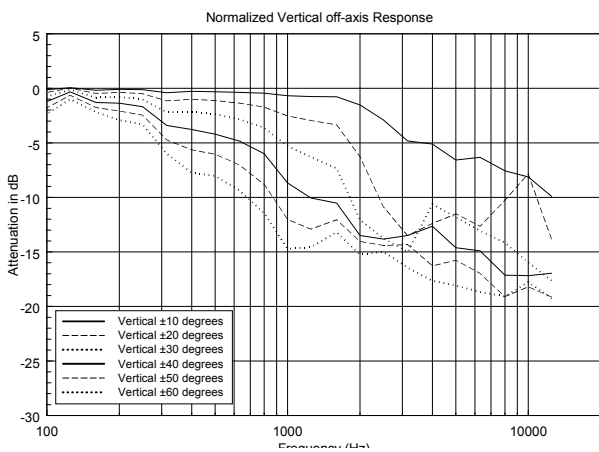
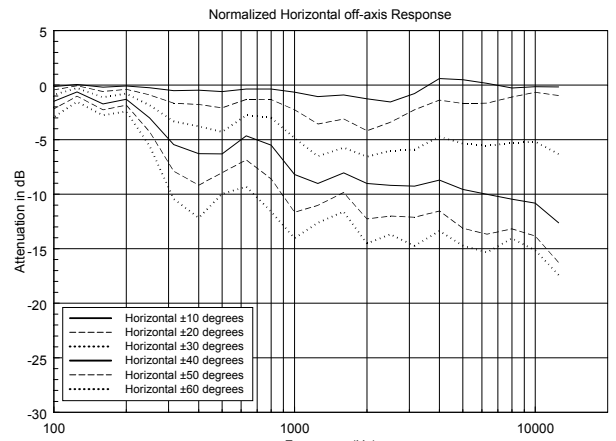
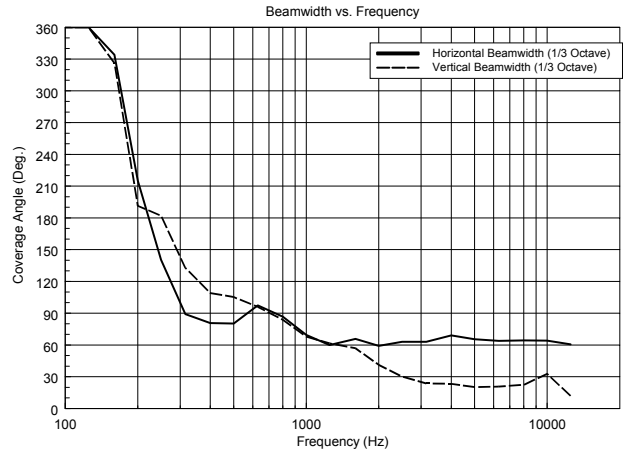
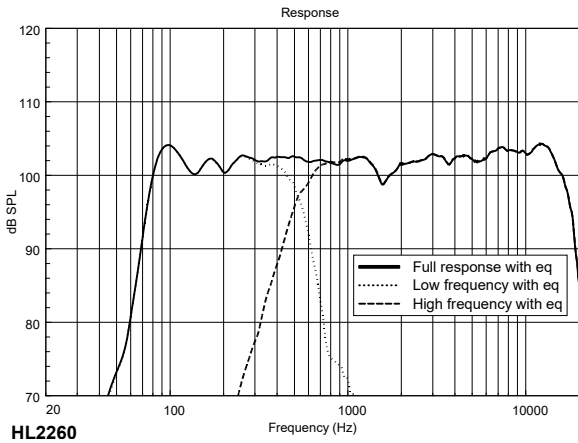

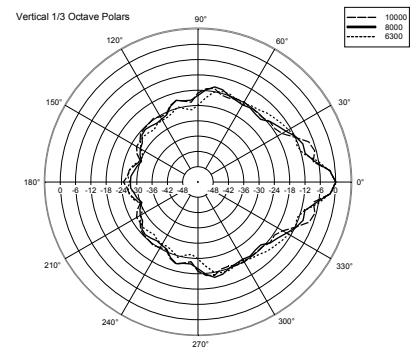
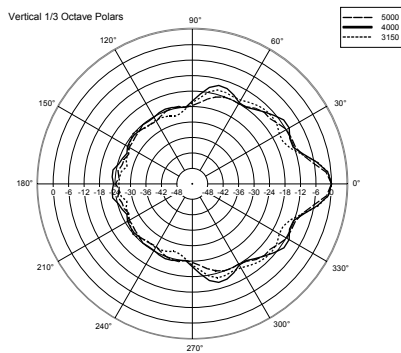
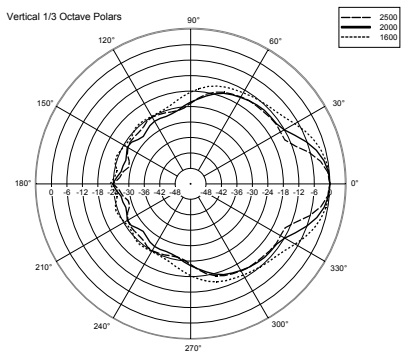
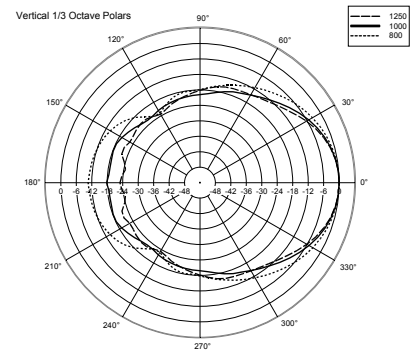
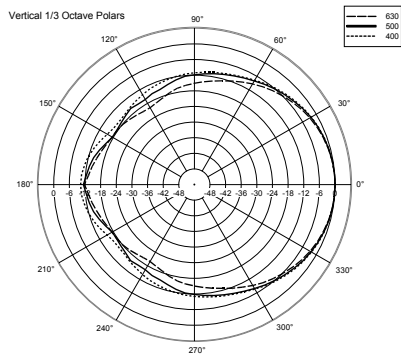
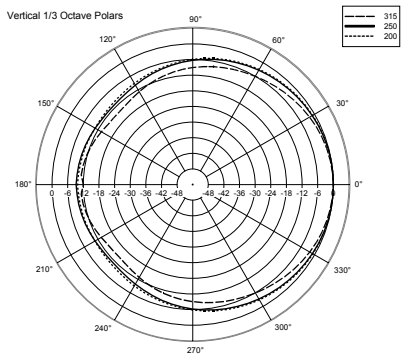
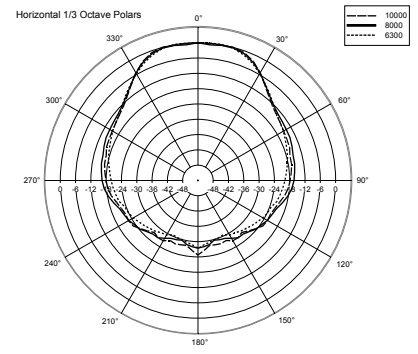
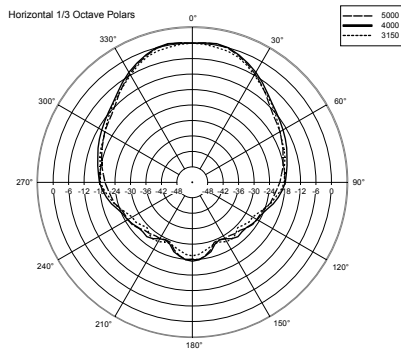
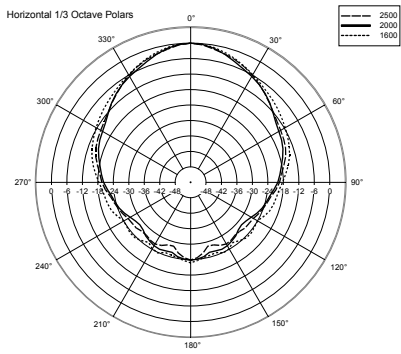
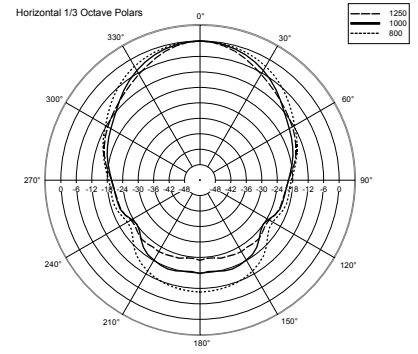
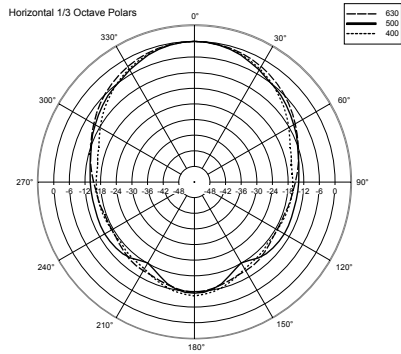
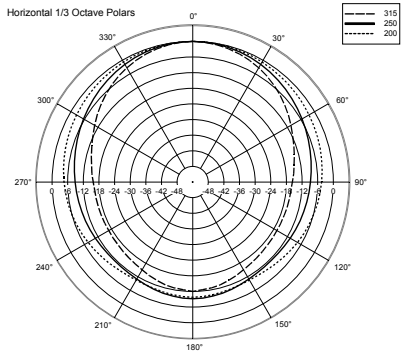

ACCESSORIES



FLY BAR FL-B HL

PART NUMBER **13360282**

EAN: 8024530011734



A&E SPECIFICATIONS

The product shall be is a horn loaded two-way bi-amped array system that incorporates 2 x 12" woofer and a titanium dome 4.0" voice coil compression driver for mid distance and long throw applications. The system shall be compact and provide very high output and accurate voice and sound reproduction. The system shall have a 60° x 22.5° constant directivity to be ideally used in point source configuration for mid distance applications or clustered with narrower angles for long throw applications. The loudspeaker enclosure shape shall be trapezoidal and offer a 22.5° coupling angle each side. Connections to the amplifier shall be made through a watertight Amphenol multi-pole connector. The grille shall be in perforated steel, epoxy coated, with open-cell fibres and water repellent woven fabric backing. The cabinet shall be constructed of Baltic birch marine plywood and finished in a very resistant, textured, polyurea black paint. The product shall be weatherproof with protection code IP 55.
