

# TTL 4-A

## ENCEINTE ACTIVE À DEUX VOIES POUR LINE ARRAY

### DESCRIPTION

L'enceinte-module TTL 4-A apporte un son de très haute qualité, à la hauteur des événements les plus exigeants, en intérieur ou en extérieur, pour une couverture petite à moyenne. Sa conception apporte aux ingénieurs du son le meilleur équilibre tonal et une excellente intelligibilité, et allie discrétion et adaptabilité. Conçue pour les applications professionnelles, elle possède tous les avantages de la technologie TT+ (directivité contrôlée, grande portée, puissance et précision).



### CARACTÉRISTIQUES

- 135 dB SPL max.
- 2 modules d'amplification Classe D, puissance totale 1600 W RMS
- 2 haut-parleurs de grave 10" à aimant en néodyme, bobine mobile 3,0"
- Tweeter moteur à chambre de compression et aimant en néodyme, sortie 1,5" / bobine mobile 4"
- Couverture 100° x 25
- Réponse en fréquence 45 - 20000 Hz
- RDNet intégré
- Technologie FIRPHASE, filtres à phase linéaire (0° de rotation)

## SPÉCIFICATIONS

<b>Spécifications acoustiques</b>	Réponse en fréquence :	45 Hz ÷ 20000 Hz
	SPL max. @ 1m:	135 dB
	Angle de couverture horizontale:	100°
	Angle de détection vertical:	25°
<b>Hauts-parleurs</b>	Pilote de compression :	1 x 1.5" neo, 4.0" v.c
	Woofers :	2 x 10" neo, 3.0" v.c
<b>Sections entrées/sorties</b>	Signal d'entrée :	bal/unbal
	Connecteurs d'entrée :	XLR, RDNet Ethercon
	Connecteurs de sortie :	XLR, RDNet Ethercon
	Sensibilité d'entrée :	+4 dBu
<b>Section processeur</b>	Fréquences de recouvrement :	900Hz
	Protections :	Thermal, RMS
	Limiteur :	Fast Limiter
	Commandes :	Selectable preset, volume, delay
	RDNet :	Yes
<b>Section alimentation</b>	Puissance totale :	3200 W Peak, 1600 W RMS
	Hautes fréquences :	1200 W Peak, 600 W RMS
	Basses fréquences :	2000 W Peak, 1000 W RMS
	Système de refroidissement :	Convection
	Connexions :	Powercon IN/OUT
<b>Conformité standard</b>	Safety agency:	CE compliant
<b>Spécifications physiques</b>	Matériau du cabinet/caisson :	Baltic birch plywood
	Matériel :	Array fittings, 2xM10 on the top, 2xM8
	Poignées :	2 side, 2 rear
	Montage sur pied/embase:	Yes
	Grille :	Steel
	Couleur :	Black
<b>Taille</b>	Hauteur :	825 mm / 32.48 inches
	Largeur :	316 mm / 12.44 inches
	Profondeur :	369 mm / 14.53 inches
	Poids :	30.4 kg / 67.02 lbs
<b>Infos colisage</b>	Hauteur du colis :	410 mm / 16.14 inches
	Largeur du colis :	865 mm / 34.06 inches
	Profondeur du colis :	365 mm / 14.37 inches
	Poids du colis :	33.5 kg / 73.85 lbs



**NUMÉRO DE PIÈCE**

- **13000584**

TTL 4-A

EAN 8024530017576

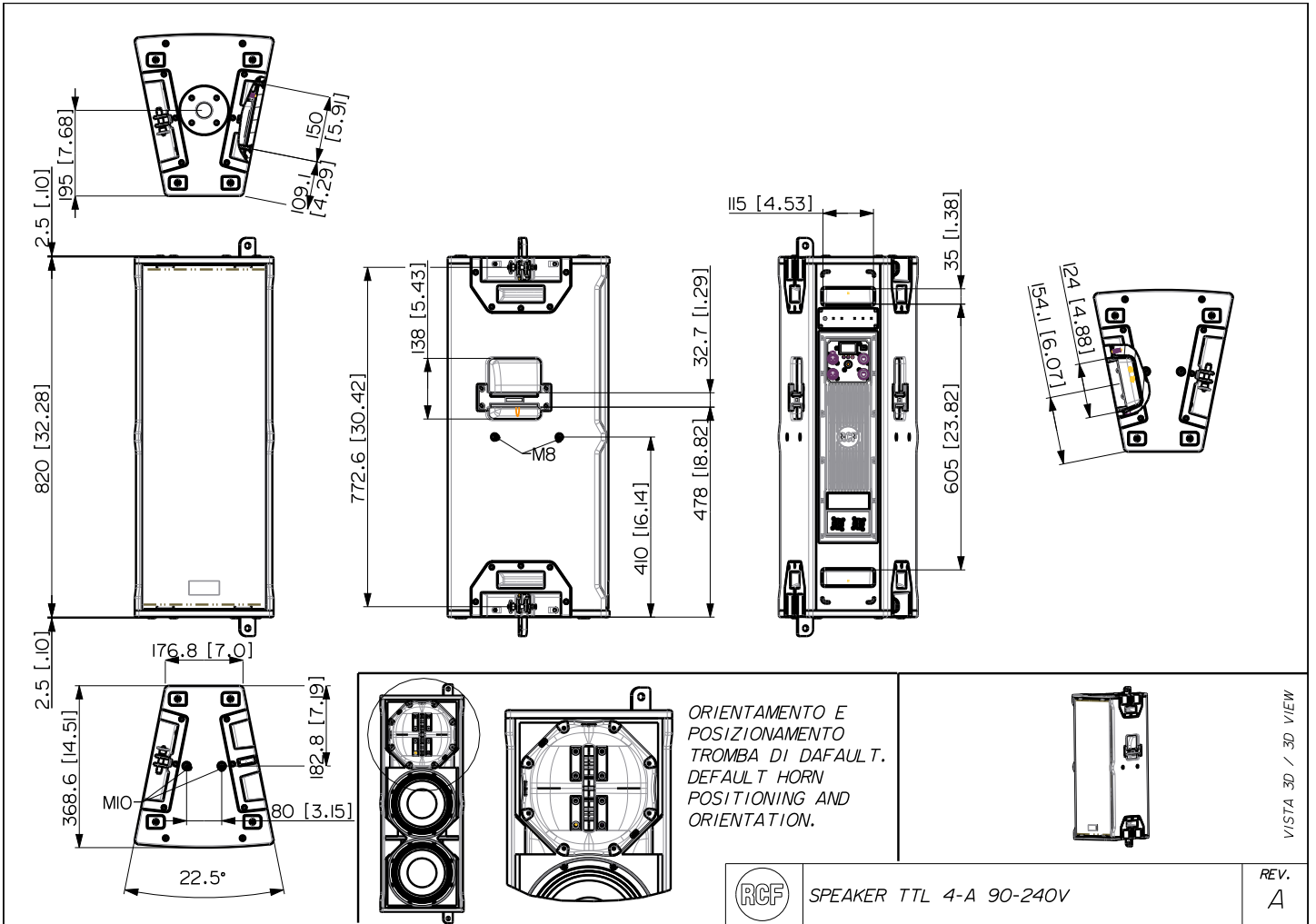

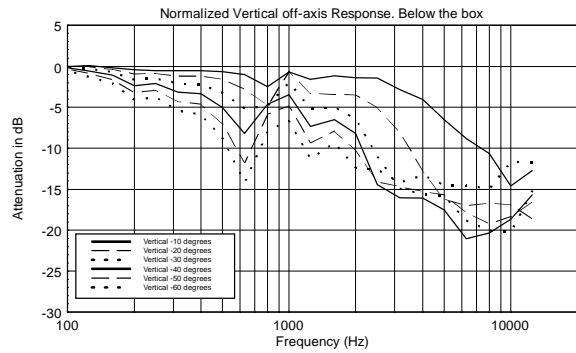
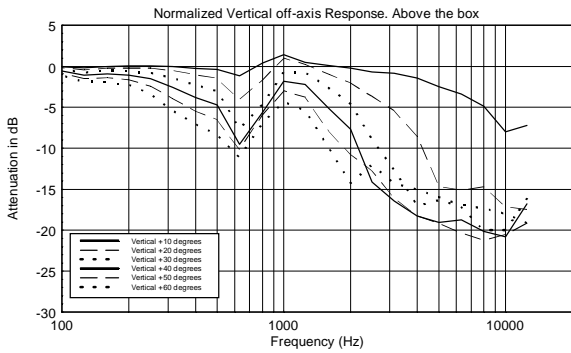
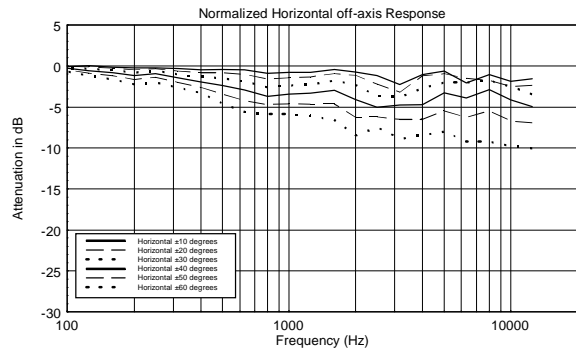
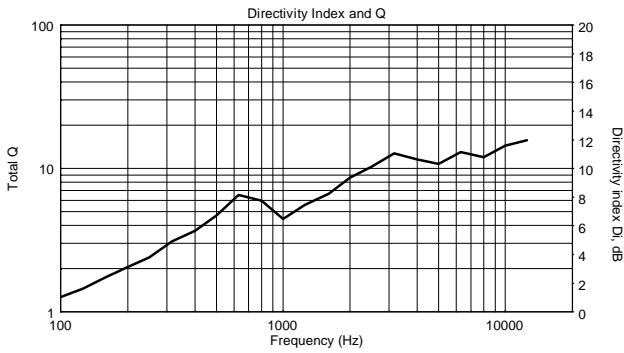
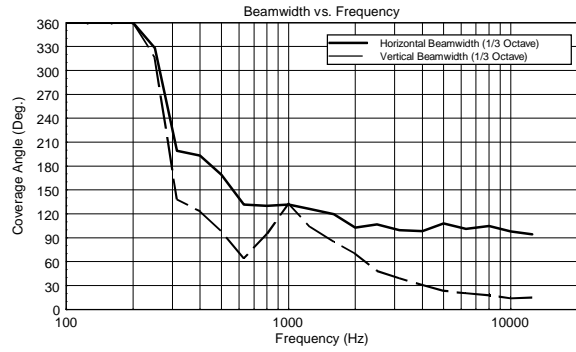
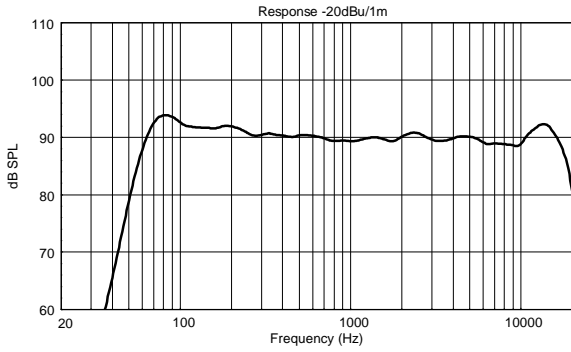

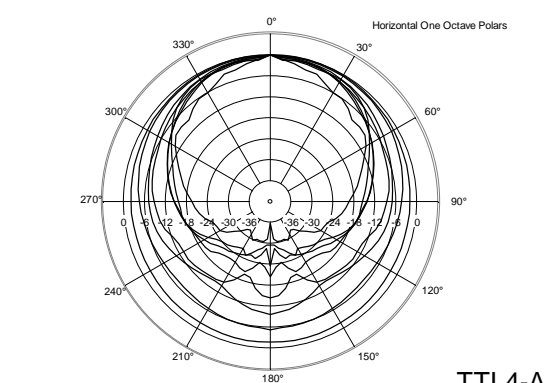
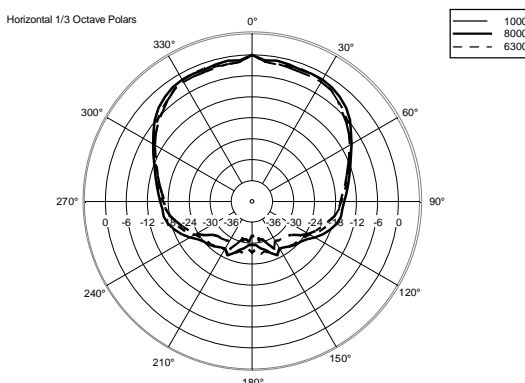
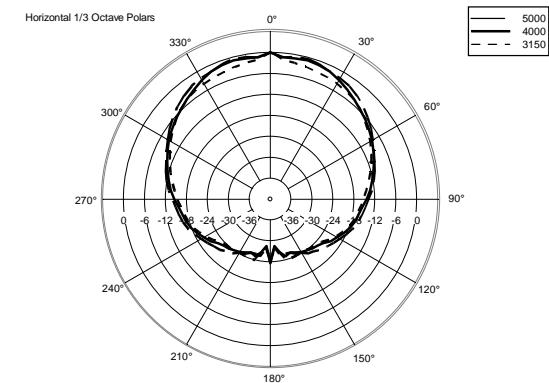
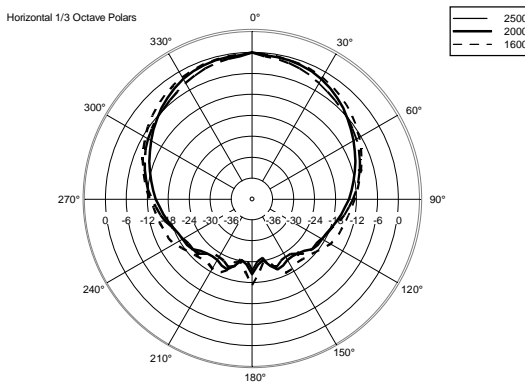
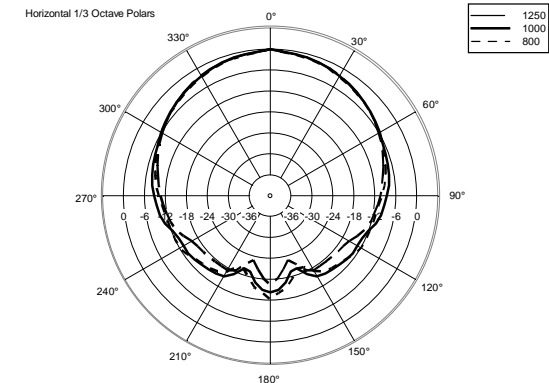
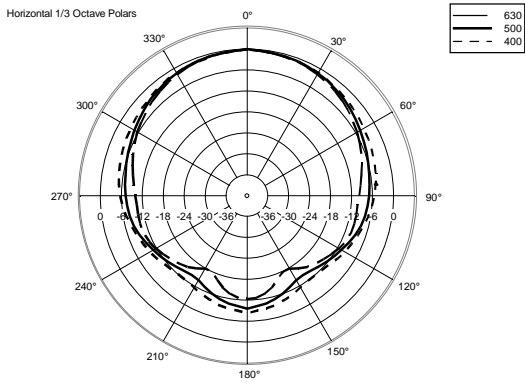
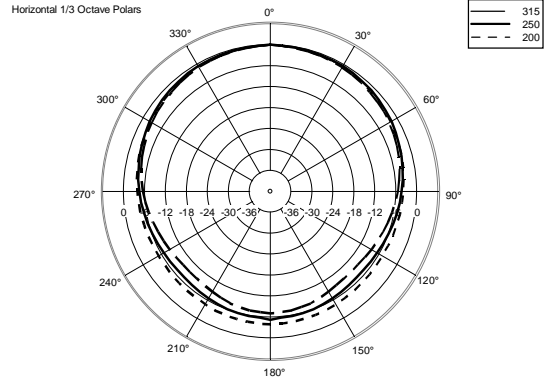
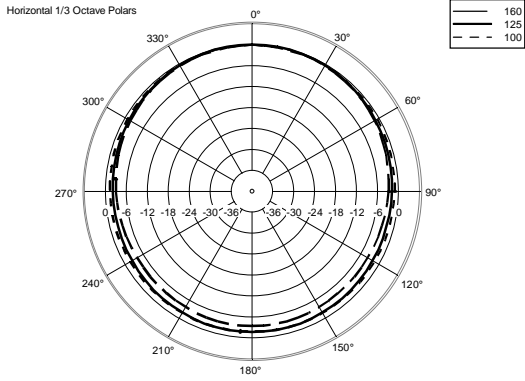

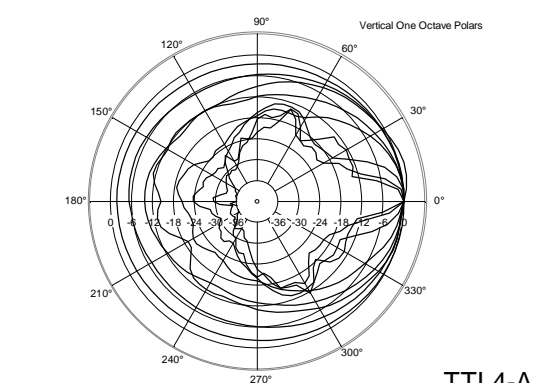
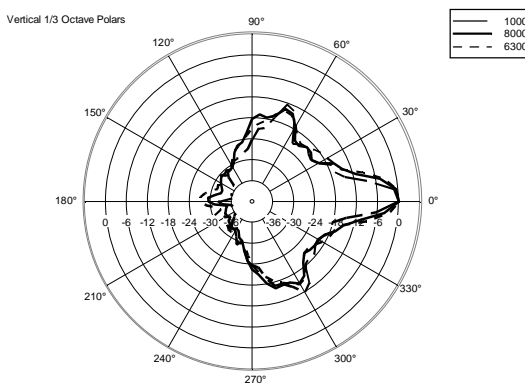
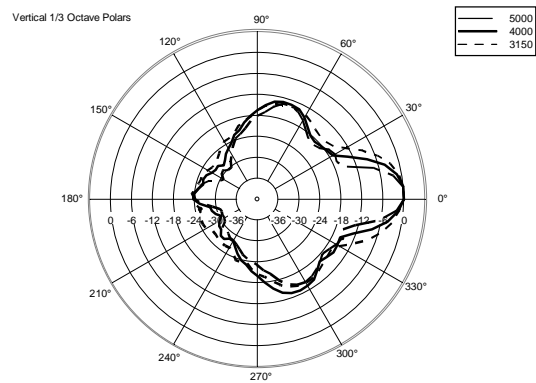
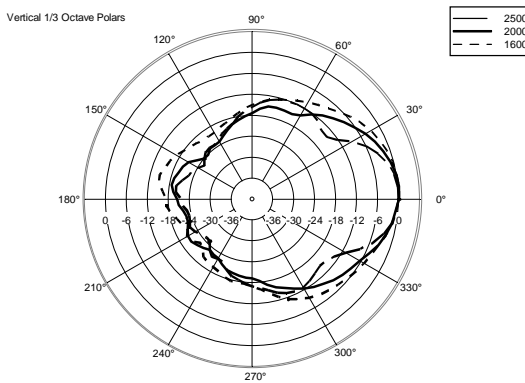
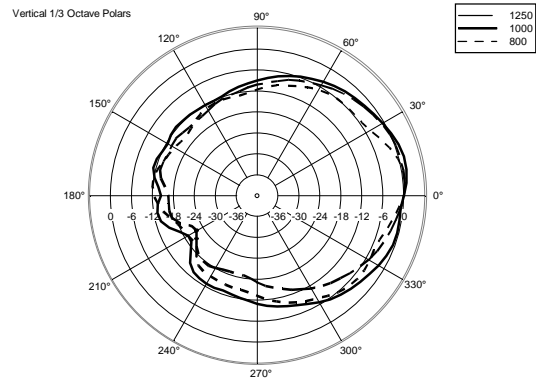
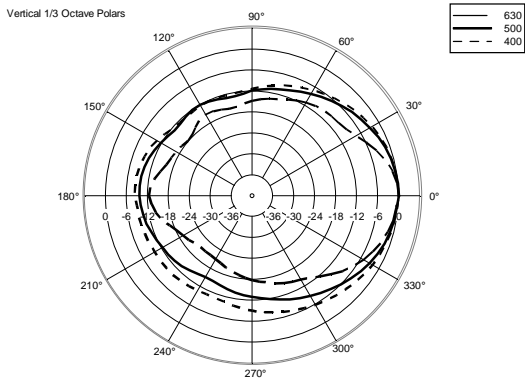
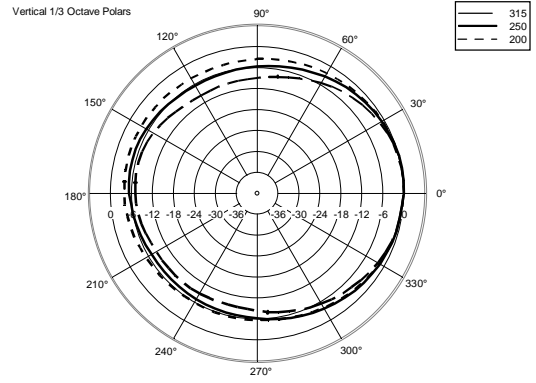
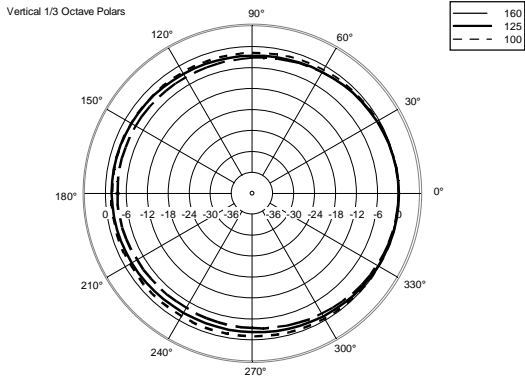



















## ACCESSOIRES

	AC PMX POLE MOUNT M20	NUMÉRO DE PIÈCE EAN:	<b>13360232</b> 8024530010058
	AC PRO-FS PROFESS. LOCKING FLOOR STAND	NUMÉRO DE PIÈCE EAN:	<b>13360109</b> 8024530006471
	AC PRO-PM PROFESS. LOCKING POLE MOUNT	NUMÉRO DE PIÈCE EAN:	<b>13360110</b> 8024530006488
	CABLES KIT CBL ETHERCON 0.7M	NUMÉRO DE PIÈCE EAN:	<b>12399016</b> 8024530013844
	CABLES KIT CBL ETHERCON 1.5M	NUMÉRO DE PIÈCE EAN:	<b>12399017</b> 8024530013851
	CABLES KIT CBL ETHERCON 3M	NUMÉRO DE PIÈCE EAN:	<b>12399035</b> 8024530013868
	CABLES KIT CBL ETHERCON 5M	NUMÉRO DE PIÈCE EAN:	<b>12399018</b> 8024530013875
	CABLES KIT CBL ETHERCON TO XLR F 0.2M	NUMÉRO DE PIÈCE EAN:	<b>12399019</b> 8024530013882
	CABLES KIT CBL ETHERCON TO XLR M 0.2M	NUMÉRO DE PIÈCE EAN:	<b>12399020</b> 8024530013899

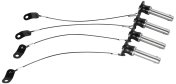

	CABLES KIT CBL POWERCON LINK 0.7M	NUMÉRO DE PIÈCE EAN:	<b>12399031</b> 8024530013738
	CABLES KIT CBL POWERCON LINK 1.5M	NUMÉRO DE PIÈCE EAN:	<b>12399030</b> 8024530013721
	COVER CVR TT 4	NUMÉRO DE PIÈCE EAN:	<b>13360440</b> 8024530017583
	FLY BAR FL-B H TT 4	NUMÉRO DE PIÈCE EAN:	<b>13360425</b> 8024530018498
	FLY BAR FL-B V TT 4	NUMÉRO DE PIÈCE EAN:	<b>13360423</b> 8024530017668
	FLY BAR PICKUP FL-B PK HDL 6	NUMÉRO DE PIÈCE EAN:	<b>13360372</b> 8024530014353
	HOIST SPACING CHAIN CH 001	NUMÉRO DE PIÈCE EAN:	<b>13360129</b> 8024530020774
	LINK BAR FL-B LINK TT 4	NUMÉRO DE PIÈCE EAN:	<b>13360428</b> 8024530017620
	QUICK LOCK PIN QL-PIN D11.2 L31 4X	NUMÉRO DE PIÈCE EAN:	<b>13360335</b> 8024530013257
	RAIN PROTECTION RP 1X HDL 30	NUMÉRO DE PIÈCE EAN:	<b>13360388</b> 8024530015138



VERTICAL BRACKET V-BR TT 4

NUMÉRO DE  
PIÈCE  
EAN:

**13360427**  
8024530017637

---